

Operating and installation instructions

Cooker hood

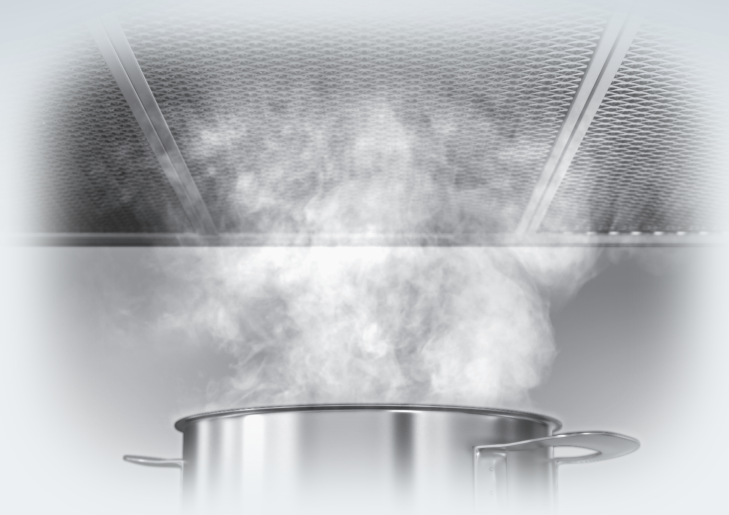

To prevent the risk of accidents or damage to the appliance, it is **essential** to read these instructions before it is installed and used for the first time.

Contents

Warning and Safety instructions	4
Caring for the environment	13
Guide to the appliance	14
Modes of operation	16
Before using for the first time	17
Select Extraction mode or Recirculation mode.....	17
Setting up Miele@home	17
Connecting via the app	18
Connecting via WPS	19
Sign out of WiFi (reset to factory settings)	20
Setting up Con@ctivity	21
Con@ctivity via the home WiFi network (Con@ctivity 3.0)	22
Con@ctivity via a direct WiFi connection (Con@ctivity 3.0)	22
Con@ctivity with direct wireless connection (Con@ctivity 2.0)	23
Operation (Automatic mode)	27
Cooking with Con@ctivity (Automatic mode).....	27
Leaving automatic mode temporarily.....	29
Returning to automatic mode.....	29
Operation (Manual mode)	30
Cooking without Con@ctivity (Manual mode)	30
Switching the fan on.....	30
Selecting the power level	30
Selecting the run-on time	30
Switching the fan off	30
Dimming/switching the hob lighting on/off	31
Power management	31
Safety switch-off	32
Operation (Automatic and Manual modes)	33
Operating hours counter	33
Altering the operating hours counter for the grease filter(s).....	33
Altering or deactivating the charcoal filter operating hours counter	34
Reading the filter operating hours counter.....	34
Energy saving tips	35
Cleaning and care	36
Housing	36

Grease filter(s)	37
Resetting the grease filter operating hours counter	39
Charcoal filter	39
Resetting the charcoal filter operating hours counter	40
Disposing of charcoal filters	40
Reactivatable charcoal filter	40
Installation	41
Before installation.....	41
Installation instructions.....	41
Assembly parts.....	42
Appliance dimensions	44
Safety distance between hob and cooker hood (S)	45
Installation recommendations	46
Drilling diagram for wall mounting.....	46
Connection for air extraction	47
Condensate trap.....	48
Silencer.....	48
Electrical connection	50
After Sales / Warranty	51
Position of the data plate	51
Technical data	52
Accessory required for recirculation mode	52
Conformity declaration	53
Note for test institutes	53

Warning and Safety instructions

This appliance complies with all relevant local and national safety requirements. Inappropriate use can, however, lead to personal injury and damage to property.

To avoid the risk of accidents and damage to the appliance, please read these instructions carefully before using it for the first time. They contain important notes on the safety, installation, use and maintenance of the appliance. Miele cannot be held liable for non-compliance with these instructions.

Keep these instructions in a safe place and ensure that all users are familiar with the contents. Pass them on to any future owner of the appliance.

Correct application

- ▶ This cooker hood is intended for use in domestic households and similar working and residential environments.
- ▶ The cooker hood is not intended for outdoor use.
- ▶ It must only be used as a domestic appliance to extract vapours and remove odours from cooking. Any other usage is not supported by the manufacturer and could be dangerous.
- ▶ Where a recirculation cooker hood is fitted above a gas hob, please ensure that there is an adequate supply of fresh air into the room in which it is installed. Please seek the advice of a qualified gas fitter (e.g. GasSafe in the UK) if necessary.

Warning and Safety instructions

▶ The cooker hood can only be used by people with reduced physical, sensory or mental capabilities, or lack of experience and knowledge, if they are supervised whilst using it, or have been shown how to use it in a safe way and recognise and understand the consequences of incorrect operation.

Safety with children

- ▶ Children under 8 years of age must be kept away from the cooker hood unless they are constantly supervised.
- ▶ Children 8 years and older may only use the cooker hood unsupervised if they have been shown how to use it safely and recognise and understand the consequences of incorrect operation.
- ▶ Children must not be allowed to clean or maintain the cooker hood unsupervised.
- ▶ Please supervise children in the vicinity of the cooker hood and do not let them play with it.
- ▶ The hob lighting is very intensive.
Ensure, in particular, that babies/small children do not look at the light.
- ▶ **Danger of suffocation!**
Whilst playing, children may become entangled in packaging material (such as plastic wrapping) or pull it over their head with the risk of suffocation. Keep packaging material away from children.

Warning and Safety instructions

Technical safety

- ▶ Unauthorised installation, maintenance and repairs can cause considerable danger for the user. Installation, maintenance and repairs must only be carried out by a Miele authorised technician.
- ▶ A damaged appliance can be dangerous. Check it for visible signs of damage. Do not use a damaged appliance.
- ▶ The electrical safety of this appliance can only be guaranteed when correctly earthed. It is essential that this standard safety requirement is met. If in any doubt please have the electrical installation tested by a qualified electrician.
- ▶ Reliable and safe operation of this cooker hood can only be assured if it has been connected to the mains electricity supply.
- ▶ The connection data (voltage and frequency) on the data plate of the cooker hood must match the mains electricity supply in order to avoid the risk of damage to the cooker hood
Compare this before connecting the appliance to the mains. Consult a qualified electrician if in any doubt.
- ▶ Do not connect the appliance to the mains electricity supply by a multi-socket unit or an extension lead. These are a fire hazard and do not guarantee the required safety of the appliance.
- ▶ EXT model cooker hoods are connected to their external motor using a special connection cable and plug connectors.
These appliances may only be combined with a Miele external motor.

Warning and Safety instructions

- ▶ For safety reasons, this appliance may only be used after it has been built in.
- ▶ The cooker hood must not be used in a non-stationary location (e.g. on a ship).
- ▶ Touching electrical components and tampering with electrical and mechanical parts is highly dangerous to the user and can cause operational faults.
Only open the housing as described in the instructions given in the installation sheet and in the Cleaning and care section of this booklet. Under no circumstances should any other parts of the housing be opened.
- ▶ The manufacturer's warranty will be invalidated if the appliance is not repaired by a Miele approved service technician.
- ▶ Miele can only guarantee the safety of the appliance when genuine original Miele replacement parts are used. Faulty components must only be replaced by Miele spare parts.
- ▶ If the electrical connection cable is faulty it must only be replaced by a Miele authorised service technician to protect the user from danger.
- ▶ During installation, maintenance and repair work, the appliance must be disconnected from the mains electricity supply.

Warning and Safety instructions

Using at the same time as another heating appliance that depends on the air from the room

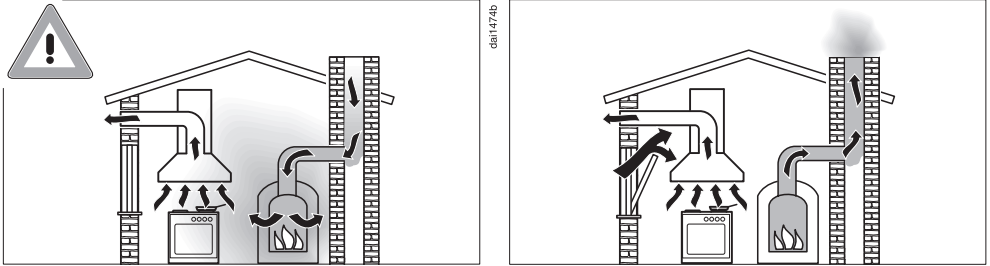

Danger of toxic fumes!

Great care should be taken when using the cooker hood in the same room or the same area of the house at the same time as another heating appliance that depends on the air from the room. Such heating appliances draw in air from the room and duct exhaust gases out to the open air through a chimney or extraction ducting. They include gas, oil, wood and coal-fired boilers and heaters, continuous flow or other water heaters, gas hobs and ovens.

The cooker hood draws in air from the kitchen and from neighbouring rooms. This applies to the following modes of operation:

- extraction mode,
- extraction mode with an external motor,
- recirculation mode with a recirculation box installed outside the room.

If there is insufficient air, an underpressure will occur. The heating appliance may be starved of oxygen. This impairs combustion. Harmful gases could be drawn from the chimney or extraction ducting back into the room.

Risk of death!

Warning and Safety instructions

In order to ensure safe operation and to prevent gases given off by the heating appliance from being drawn back into the room, when the cooker hood and the heater are both operated simultaneously, an underpressure in the room of 0.04 mbar (4 Pa) is the maximum permissible.

Sufficient ventilation can be maintained by air inlets which cannot be blocked, e.g. in windows, doors and outside wall vents. The diameter of the inlet openings must enable sufficient ventilation. A ventilation brick alone is not generally sufficient to ensure safe ventilation.

The overall ventilation condition of the dwelling must be taken into account. If in any doubt, the advice of a competent builder, or for gas, a qualified gas fitter should be sought.

If the cooker hood is being operated in recirculation mode, whereby the air is redirected into the room in which it is installed, the above restrictions do not apply.

Warning and Safety instructions

Correct use

- ▶ Never use a naked flame beneath the cooker hood. To avoid the danger of fire, do not flambé or grill over a naked flame. When switched on, the cooker hood could draw flames into the filter. Fat deposits could ignite, presenting a fire hazard.
- ▶ The cooker hood can become damaged when exposed to excessive heat.
 - When using the cooker hood over a gas hob, ensure that any burners in use are always covered by a pan. Switch the cooking zone off when a pan is removed, even for a short time.
 - Select a pan which is suitable for the size of the burner.
 - Regulate the flame so that it does not burn up the sides of the pan.
 - Avoid overheating the pan (e.g. when cooking with a wok).
- ▶ Always switch the cooker hood on when a cooking zone is in use, otherwise condensation may collect in the hood, which could cause corrosion.
- ▶ Overheated oil and fat can ignite, causing fire damage to the cooker hood. When cooking with oil or fat, chip pans and deep fat fryers etc, do not leave the pans unattended. Similarly, never leave an open grill unattended when grilling.

Warning and Safety instructions

▶ Do not use the cooker hood without the filters in place. This way you will avoid the risk of grease and dirt getting into the appliance and hindering its smooth operation.

▶ There is a risk of fire if the cooker hood is not cleaned as described in these operating instructions.

▶ The cooker hood can get very hot during cooking due to heat rising from the hob.

Do not touch the housing or the grease filters until the cooker hood has cooled down.

Correct installation

▶ Refer to the cooker or hob manufacturer's instructions as to whether a cooker hood may be operated above the cooker/hob.

▶ Safety regulations prohibit the fitting of a cooker hood over solid fuel stoves.

▶ An insufficient safety distance between the hob and the cooker hood can result in damage to the cooker hood.

The minimum safety distances between the top of the cooker or hob and the bottom of the cooker hood given in the "Installation" section of this booklet must be maintained, unless the hob manufacturer states that a greater safety distance is required.

If more than one cooking appliance is fitted beneath the cooker hood, and they have different minimum safety distances to the cooker hood, select the greater distance.

▶ The distances given in "Installation" must be observed when fitting the cooker hood.

▶ Metal parts can have sharp edges which may cause injury. Wear gloves to protect your hands from being cut.

▶ Exhaust ducting must be of non-inflammable material. Suitable material is available from Miele specialist dealers or the Miele Spares Dept.

Warning and Safety instructions

- ▶ The appliance must not be connected to a chimney or flue which is in use. Neither should it be connected to ducting which ventilates rooms with fireplaces.
- ▶ If exhaust air is to be extracted into a chimney or ventilation duct no longer used for other purposes, seek professional advice.

Cleaning and care

- ▶ There is a risk of fire if the cooker hood is not cleaned as described in these operating instructions.
- ▶ Do not use a steam cleaning appliance to clean this appliance. The steam could reach electrical components and cause a short circuit.

Accessories

- ▶ Only use genuine original Miele accessories and spare parts with this appliance. Using accessories or spare parts from other manufacturers will invalidate the warranty and Miele cannot accept liability.

Disposal of the packing material

The packaging is designed to protect the appliance from damage during transportation. The packaging materials used are selected from materials which are environmentally friendly for disposal and should be recycled.

Recycling the packaging reduces the use of raw materials in the manufacturing process and also reduces the amount of waste in landfill sites.

Disposing of your old appliance

Electrical and electronic appliances often contain valuable materials. They also contain specific materials, compounds and components, which were essential for their correct function and safety. These could be hazardous to human health and to the environment if disposed of with your domestic waste or if handled incorrectly. Please do not, therefore, dispose of your old appliance with your household waste.



Please dispose of it at your local community waste collection / recycling centre for electrical and electronic appliances, or contact your dealer or Miele for advice. You are also responsible (by law, depending on country) for deleting any personal data that may be stored on the appliance being disposed of. Please ensure that your old appliance poses no risk to children while being stored prior to disposal.

Guide to the appliance

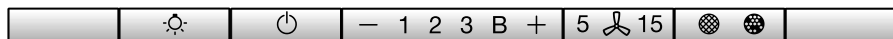
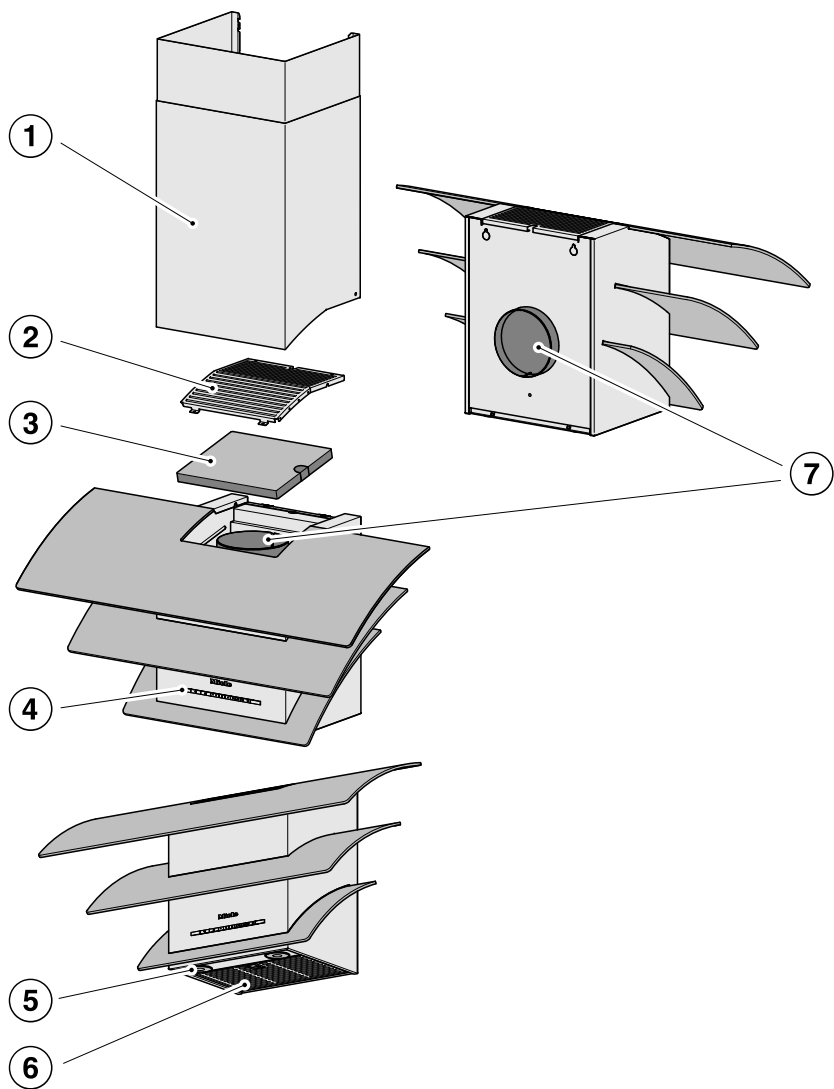

8

9

10

11

12

- ① DADC 7000 tower
Available as an optional accessory for concealing extraction ducting to the ceiling.
- ② Fascia (only for recirculation mode or for extraction to the rear)
- ③ Charcoal filter
Accessory required for recirculation mode
- ④ Controls
- ⑤ Hob lighting
- ⑥ Grease filter
- ⑦ Exhaust ducting connection
The ducting can be directed through the back of the cooker hood or upwards through the ceiling.
- ⑧ Control for switching the lighting on and off and for dimming the lighting
- ⑨ Control for switching the fan on and off
- ⑩ Controls for setting the fan power level
- ⑪ Control for the run-on function
- ⑫ Control for the operating hours counter
This control is used for displaying operating hours used and for altering the counter setting. See “Before using for the first time” for details on how to set the counter for Extraction mode or for Recirculation mode.

Modes of operation

Depending on the model of the cooker hood, the following options are available:

Extraction mode

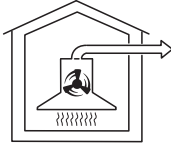

da00494a

The air is drawn in and cleaned by the grease filter and directed outside.

Non-return flap

The non-return flap is designed to prevent the exchange of room and outside air taking place when the cooker hood is switched off.

The flap is closed when the cooker hood is switched off.

When the cooker hood is switched on, the non-return flap opens for the cooking vapours to be blown directly outside.

If the on-site ventilation system does not have a non-return flap, the non-return flap supplied must be fitted in the exhaust socket in the motor unit.

Recirculation mode

Recirculation mode cooker hoods require charcoal filters. These are available as optional accessories: see “Technical Data”.



da00494b

The air is drawn in and cleaned first by the grease filter and then by a charcoal filter. The cleaned air is then recirculated back into the kitchen.

Operation with an external motor

(...EXT model cooker hoods)

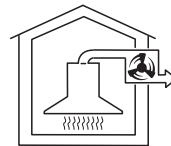



da00494c

Cooker hoods designed for use with an external motor have to be connected to a Miele external motor located in a position of your choice outside the room. The external motor is connected to the cooker hood by means of a control cable and is operated via Con@ctivity or by the controls on the cooker hood.



Select Extraction mode or Recirculation mode

The cooker hood is suitable for both extraction mode and recirculation mode. The power of the fan is adapted to suit the selected mode of operation. The cooker hood is set up ex-works for recirculation mode. It has to be re-set for extraction mode.

To re-set it for extraction mode the operating hours counter for the charcoal filter(s) has to be deactivated.

- Switch off the fan and the lighting.
- Press the + control and the operating hours control   at the same time.

The Charcoal filter symbol  and one of the fan power levels will flash.

- Press and hold the + control until the **B** indicator lights up.
- Confirm your choice with the operating hours control  .

All the indicator lights will go out.

Extraction mode has now been set.

If you don't confirm your selection within 4 minutes, the cooker hood will automatically revert to the original setting.

Setting up Miele@home

Prerequisite:

- Home WiFi network

Your cooker hood is equipped with an integrated WiFi module. The cooker hood can be connected to the household WiFi network.

You will then be able to operate the cooker hood via the Miele@mobile app.

If your Miele hob is connected to a home WiFi network, you can control the cooker hood automatically via the Con@ctivity function.

Before installing the cooker hood in its final location, ensure that the signal of your WiFi network is strong enough.

Please note that you cannot set up a WiFi connection at the same time as the wireless Con@ctivity 2.0 system.

Before using for the first time

Miele@mobile App

The Miele@mobile App is available to download free of charge from the Apple App Store® or from the Google Play Store™.



Connecting via the app

The Miele@mobile app can be used to connect to your network.

- Install the Miele@mobile app on your mobile device.

To log in you will need:

1. Your WiFi network password
2. Your cooker hood password



The password for your cooker hood consists of the last nine digits of the serial number. This can be found on the appliance's data plate.

The data plate is visible after removing the grease filter.



- Start signing the appliance on in the app. Follow the signing in instructions.

If requested to activate WiFi on the cooker hood, proceed as follows:

Before using for the first time

- Switch the cooker hood off.



- Press and hold the + control.



- Press the lighting control at the same time .

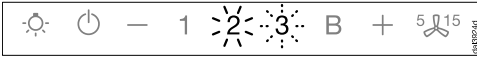

2 will light up constantly, **3** will flash on and off.

The cooker hood is ready for connection in the next two minutes.



- Follow the instructions in the app.

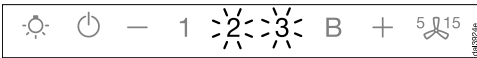

When successfully connected the **2** and **3** will light up constantly.



- Quit connection mode on the cooker hood by pressing the Run-on control .

The cooker hood can now be operated via the app.

Connecting via WPS

Your WiFi router must support WPS (WiFi Protected Setup).

- Switch the cooker hood off.



- Press and hold the + control.



- Press the lighting control at the same time .

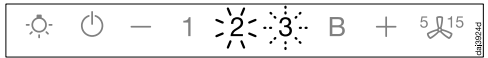

2 will light up constantly, **3** will flash on and off.

The WiFi connection must be started on the cooker hood at the same time as on the WiFi router.

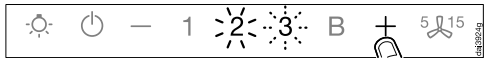

- Press the + control on the cooker hood after a few seconds.

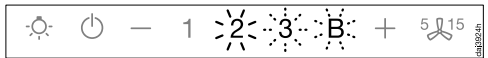

After a short while the **2** will light up constantly, and the **3** and the **B** will flash on and off.

The cooker hood is ready for connection in the next two minutes.

Before using for the first time



- Start the WiFi connection on your WiFi router.

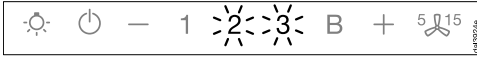

When successfully connected the **2** and **3** will light up constantly.



- Quit connection mode on the cooker hood by pressing the Run-on control .

The cooker hood can now be operated via the app.

If the connection fails, you have probably not connected WPS on your router quickly enough. Repeat the steps above.

Tip: If your WiFi router does not support WPS, please connect via the Miele@mobile app.

Sign out of WiFi (reset to factory settings)

To set up a new WiFi connection, the existing WiFi connection must be disconnected.

- Switch the cooker hood off.



- Press and hold the **–** control.



- Touch the lighting control at the same time .

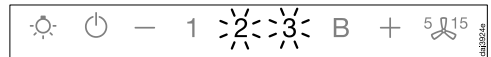

With an existing WiFi connection the **2** and the **3** will light up constantly.

The cooker hood is ready for disconnection in the next two minutes.

Before using for the first time



- Touch the — control.

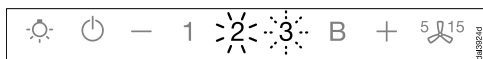

2 will light up constantly, **3** will flash on and off.

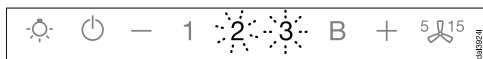

After a few seconds the **2** and the **3** will flash on and off. The connection has now been disconnected.



- Quit disconnection mode on the cooker hood by pressing the Run-on control ⁵ 15.

The WiFi connection has now been disconnected. A new connection can now be set up.

Setting up Con@ctivity

Con@ctivity is the direct communication system between an electric Miele hob and a Miele cooker hood. It enables the cooker hood to operate automatically depending on the operational state of a Miele hob with onset controls.

- When the hob is switched on, the cooker hood lighting comes on automatically and then after a short time the fan also comes on.
- The cooker hood selects the power level automatically during cooking. The power level selected by the cooker hood depends on the number of cooking zones being used and their power levels.
- After switching the hob off the fan and the hob lighting will switch off automatically after a specified period of time.

See “Operation” for detailed information about this function.

Before using for the first time

This cooker hood can be operated with the Con@ctivity function via a WiFi connection (Con@ctivity 3.0) or via a wireless connection (Con@ctivity 2.0).

Con@ctivity via the home WiFi network (Con@ctivity 3.0)

Prerequisite:

- Home WiFi network
- WiFi enabled Miele hob

- Connect the cooker hood and hob to your home WiFi network (see “Setting up Miele@home”).

The Con@ctivity function will be activated automatically.

Con@ctivity via a direct WiFi connection (Con@ctivity 3.0)

Prerequisite:

- WiFi enabled Miele hob

If you do not have a home network, you can establish a direct connection between the hob and the cooker hood.

See the Hob instruction manual for details on how to connect them.

Instructions on how to connect the cooker hood are repeated in detail below.

- Switch the cooker hood off.



- Press and hold the + control.



- Press the – control at the same time.

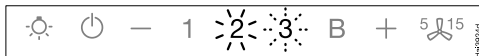

2 will light up constantly, **3** will flash on and off.

The cooker hood is ready for connection in the next two minutes.

Before using for the first time

- Start WiFi connection on the hob. For further details, see the hob operating instructions.

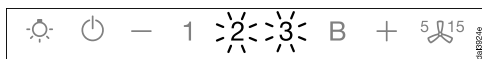

When successfully connected the **2** and **3** will light up constantly.



- Quit connection mode on the cooker hood by pressing the Run-on control **5**/**15**.

Con@ctivity has now been activated.

With a direct WiFi connection, it is not possible to connect the hob and the cooker hood to a home network. Should this be required at a later date, the WiFi connection between the hob and the cooker hood must be disconnected (see “Sign out of WiFi”).

Con@ctivity with direct wireless connection (Con@ctivity 2.0)

Prerequisite:

- Con@ctivity 2.0 enabled Miele hob

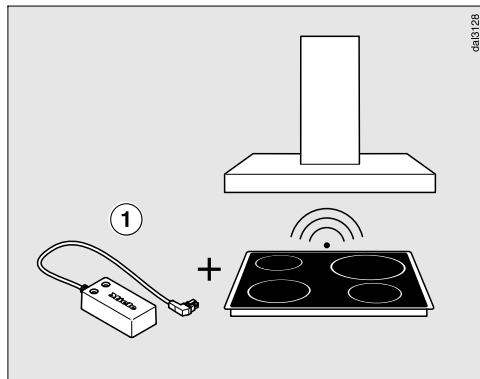

This cooker hood is supplied with a Con@ctivity 2.0 wireless stick ①.

The wireless stick can only be used with hobs that are fitted with a slot for the wireless stick to operate the Con@ctivity function.

- Check the installation instructions for the Con@ctivity 2.0 stick to ensure that it is compatible with your hob.

Please note that you cannot set up a WiFi connection at the same time as the wireless Con@ctivity 2.0 system.

Before using for the first time

Installing the Con@ctivity 2.0 stick

- See the relevant installation instructions provided with the Con@ctivity 2.0 stick.

Activating the wireless connection

The cooker hood and the hob must be installed and operational.

Wireless connection must be activated on the cooker hood and the hob at the same time. Activation on the cooker hood is described below.

Activation on the hob is described in the relevant operating and installation instructions. Please refer to the operating instructions before starting. Activate the cooker hood first, then the hob.

Activating the cooker hood

- The hob and cooker hood must be switched off.



- Press the run-on control 5 15 for approx. 10 seconds until **1** lights up.

- Then press in turn:



- the - control,



- then the + control,



- then the lighting control ☀.

The cooker hood is now in signing on/off mode.

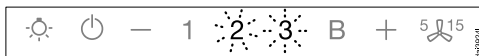

If a wireless connection has not yet been established, **2** and **3** will flash at the same time.

If a wireless connection has already been established, **2** and **3** will light up constantly (Con@ctivity 2.0 is already activated or a remote control is signed on).

Before using for the first time



- To activate Con@ctivity 2.0 press the + control.

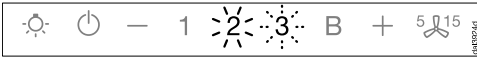

2 will light up constantly, **3** will flash on and off.

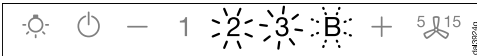

After a few seconds **2** and **3** will light up constantly, **B** will flash on and off.

The search for a wireless connection will start.

Activating the hob



- **While** the cooker hood is searching for a signal, start activating the hob. For further details, see the hob operating instructions.
- When the hob registers that a link has been established, exit activation on the hob.

Finish activation on the cooker hood

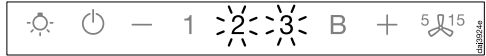

When successfully connected the **B** will go out, and the **2** and **3** will light up constantly.



- Confirm activation with the run-on control ⁵ 15. All the indicator lights will go out.

The Con@ctivity 2.0 function is now ready for use.

If confirmation is not carried out within 4 minutes, activation will not take place.

Activation only takes place once. If appliances are disconnected from the mains, for example during a power cut, the activation process does not need to be repeated.

Before using for the first time

Activation failed

If the wireless connection cannot be established despite activating the cooker hood and the hob, both appliances must first be deactivated and then re-activated.

Deactivating wireless connection

- The hob and cooker hood must be switched off.



- Press the run-on control 5 15 for approx. 10 seconds until **1** lights up.
- Then press in turn:



– the — control,



– then the + control,



– then the lighting control ☀️.

The cooker hood is now in signing on/off mode.

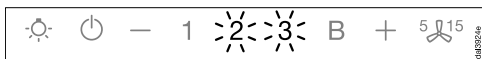

If a wireless connection has already been established, **2** and **3** will light up constantly.



- Press the — control to deactivate Con@ctivity 2.0.

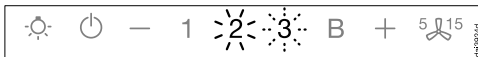

2 will light up constantly, **3** will flash on and off.

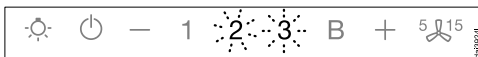

After a few seconds **2** and **3** will start flashing on and off.

The wireless connection has now been deactivated.

- To deactivate the hob, see the hob operating instructions.

Note that disabling the wireless connection will also deactivate any remote control function and this will have to be activated again.

Operation (Automatic mode)

When Con@ctivity 2.0 is active, the cooker hood always operates in Automatic mode (see “Setting up Con@ctivity 2.0”).

If you wish to manually operate the cooker hood, see "Cooking without Con@ctivity.

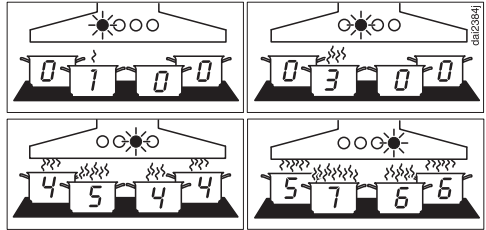

Examples for power levels **1** to **B**

Cooking with Con@ctivity (Automatic mode)

- Switch a cooking zone on at the power level you want.

The hob lighting will come on.

After a few seconds the fan will come on, first at power level **2**, then it will switch immediately to power level **1**.

The cooker hood selects the power level automatically during cooking.

This is determined by the total output of the hob, i.e, the number of cooking zones in operation and the power levels selected.

- If you select a higher power level or are using several cooking zones, the cooker hood will switch to a higher power level.
- When you reduce the power level or the number of cooking zones on the hob, the cooker hood power level is also reduced.

Reaction time

The cooker hood reacts with a slight delay because altering the power level on the hob does not immediately result in a reduction or increase in cooking vapours.

Because the hob transmits the information to the cooker hood at intervals, this can also cause delays.

The reaction can vary from a few seconds to a couple of minutes.

Operation (Automatic mode)

Cooking process

- If for example you switch on a cooking zone at the highest power level to heat a pan for frying and reduce the power level after approx. 10 seconds to 4 minutes *, a cooking process is recognised. (*60 seconds to 5 minutes for a HiLight hob.)

The cooker hood switches itself on and when the hob power level has been reduced, the hood switches to power level 3 and remains at that level for approx. 5 minutes.

After that the cooker hood power level is determined automatically by the Con@ctivity function.

- You can select another power level manually before then.

Switching off

- Switch off all cooking zones.

The cooker hood fan will reduce its power level in stages over the next few minutes and will then switch itself off.

This helps to neutralise any lingering vapours and odours in the air.

- From the Booster setting, the fan switches immediately to Level 3.
- From Level 3, it will switch to Level 2 after approx. 1 minute.
- From Level 2, it will switch to Level 1 after 2 minutes.
- After 2 minutes at Level 1 the fan switches itself off.
- After another 30 seconds, the hob lighting switches off.

The cooking process is then finished.

Leaving automatic mode temporarily

To leave automatic mode temporarily during cooking:

- manually select a different power level, or
- manually switch the cooker hood off, or
- activate the run-on function  on the cooker hood. The fan will switch itself off after the selected run-on time, and the lighting will remain on.

The cooker hood functions can now be operated manually (see “Cooking without Con@ctivity”).

Returning to automatic mode

The cooker hood will resume automatic mode:

- if the cooker hood has not been used for approx. 5 minutes after selecting a power level manually, or
- if the manually selected fan power level corresponds to the automatic one again, or
- the cooker hood fan and the hob have been switched off for at least 30 seconds.
Automatic mode will resume next time the hob is switched on.

You can also operate the cooker hood manually for a complete cooking process.

- To do so switch the cooker hood fan on **before** the hob.
If the cooker hood fan and the hob have been switched off for at least 30 seconds after cooking, automatic mode will resume next time the hob is switched on.

Operation (Manual mode)

Cooking without Con@ctivity (Manual mode)

The cooker hood can be operated manually if:

- the Con@ctivity function is not activated.
- you have temporarily deactivated the Con@ctivity function (see “Temporarily exiting Automatic mode”).

Switching the fan on

Switch the fan on as soon as you start cooking. This is to ensure that vapours are captured right from the start.

- Press the On/Off control .

The fan will switch on at setting **2** and the  symbol and **2** will light up in the power setting display.

Selecting the power level

For light to heavy cooking vapours and odours, select from power levels **1** to **3**.

For short periods of cooking food with intensive vapours and a strong aroma, e.g. when searing meat, select Booster setting **B**.

- Select the power level you want by pressing the – or + control.

Reducing power down from the Booster setting



If power management is activated (default setting), the fan automatically switches back to level **3** after 5 minutes.

Selecting the run-on time

It is advisable to run the fan for a few minutes after cooking has finished. This helps to remove any lingering vapours and odours from the air.

It also reduces the risk of residues accumulating in the cooker hood and any resultant odours.

The run-on function enables the fan to continue running for a pre-determined time before switching itself off automatically.

- After you have finished cooking, press the run-on control  while the fan is still running:
 - Once: the fan will switch itself off after 5 minutes (**5** lights up).
 - Twice: The fan will switch itself off after 15 minutes (**15** lights up).
 - If you touch the run-on option control  again, the fan will remain on ( will go out).

Switching the fan off

- Press the On/Off control  to switch the fan off.



The  symbol will go out.

Dimming/switching the hob lighting on/off

The hob lighting can be switched on and off and dimmed independently of the fan.

- Press the lighting sensor  briefly to switch it on or off.

The lighting will switch on at maximum brightness.

- With the lighting switched on, press and hold the hob lighting control . The brightness will gradually dim until you release the control.
- Press and hold the lighting  control again to increase the brightness to the level required and then release it.

Power management

The cooker hood features a power management system to help save energy. The fan power level is reduced and the lighting is switched off automatically.





- If the Booster setting has been selected, the fan will automatically switch to level 3 after 5 minutes.
- From levels 3, 2 or 1 the power will be reduced by one level after 2 hours and then in 30 minutes stages until the fan finally switches off.
- The hob lighting will switch off automatically after 12 hours.

You can deactivate Power management.

This can however result in increased electricity consumption.

Operation (Manual mode)

Switching Power management on/off

- Switch off the fan and the lighting.
- Press the fan run-on button  for approx. 10 seconds until the indicator for power level **1** lights up.
- Then press in turn:
 - the lighting control .
 - followed by the  control and then
 - the lighting control .

If Power management is switched on, the **1** and **B** indicators light up constantly.

When it is switched off, the **1** and **B** indicators flash.

- Press the  control to turn power management off.

The **1** and **B** indicators will flash.

- Press the  control to switch it on.

The **1** and **B** indicators will light up constantly.



- Confirm the setting with the run-on option control 

All the indicator lights will go out.

If you don't confirm your selection within 4 minutes, the cooker hood will automatically revert to the original setting.

Safety switch-off



If Power management has been deactivated, the cooker hood will switch itself off automatically after 12 hours if it has been left on (fan and hob lighting).

- To switch it on again press the On/Off  control or the lighting control .

Operation (Automatic and Manual modes)

Operating hours counter

The cooker hood registers the length of time it has been operated.



When the grease filter symbol  or the charcoal filter symbol  lights up, the operating hours counters are signalling that the filters need to be cleaned or changed. Further information about cleaning and replacing the filters and resetting the operating hours counter can be found under “Cleaning and care”.

Altering the operating hours counter for the grease filter(s)

You can set the operating hours counter to suit the type of cooking you do.

It is set at the factory for 30 hours.

- Select a shorter time of 20 hours if you fry a lot.
- If you only cook occasionally, we recommend that you still select a short time. This is to prevent grease hardening on the filter(s) and making cleaning more difficult
- Select a longer time of 40 or 50 hours if you use very little fat for cooking.

- Switch off the fan and the lighting.
- Press the run-on  control and the operating hours control  at the same time.

The Grease filter symbol  and one of the fan power level indicators will flash.

Fan power level indicators **1** to **B** show the time set:

1	20 hours
2	30 hours
3	40 hours
B	50 hours

- Press the **–** control for a shorter duration, or **+** for a longer duration.
- Confirm your choice with the operating hours control .

All the indicator lights will go out.

If you don't confirm your selection within 4 minutes, the cooker hood will automatically revert to the original setting.

Operation (Automatic and Manual modes)



Altering or deactivating the charcoal filter operating hours counter

The charcoal filter is needed for recirculation mode.

You can set the operating hours counter to suit the type of cooking you do.

It has to be deactivated for extraction mode.



It is set at the factory for 180 hours of use before it needs to be replaced with a new one.

- Switch off the fan and the lighting.
- Press the + control and the operating hours control   at the same time.

The Charcoal filter symbol  and one of the fan power levels will flash.

Fan power level indicators **1** to **B** show the time set:

- 1**..... 120 hours
- 2**..... 180 hours
- 3**..... 240 hours
- B**..... deactivated





- Select the duration you want with the + or – control.
- Confirm your choice with the operating hours control  .

All the indicator lights will go out.

If you don't confirm your selection within 4 minutes, the cooker hood will automatically revert to the original setting.

Reading the filter operating hours counter

You can check the percentage of time set already used before the filter needs replacing.

- Switch the fan on with the On/Off control .
- Press and hold the operating hours control  :
 - Once, to read the grease filter operating hours. The grease filter symbol  lights up.
 - Twice, to read the charcoal filter operating hours. The Charcoal filter symbol  lights up.

One or more of the power level indicators will flash.

The number of fan power level indicators flashing shows the percentage of the operating time which has already been used up.

- 1** 25 %
- 1 and 2** 50 %
- 1 to 3** 75 %
- 1 to B** 100 %

The number of operating hours used remains in the memory, even when the appliance is switched off or there is a power cut.

This cooker hood operates very efficiently and economically. The following will help you to save even more energy when using it:

- Ensure that there is sufficient ventilation in the kitchen when cooking. In extraction mode, if there is insufficient air flow the cooker hood cannot operate efficiently and this causes increased operating noise levels.
- Always cook with the lowest possible setting. This produces fewer cooking vapours, so you can use a lower cooker hood power level and therefore benefit from reduced energy consumption.
- Clean or change the filters at regular intervals. Heavily soiled filters reduce performance, increase the risk of fire and are unhygienic.
- Use the Con@ctivity function. The cooker hood will switch on and off automatically at the optimum power level for the cooking you are doing, which ensures low energy consumption.
- If you are operating the cooker hood manually, please note the following:
 - Check the power level selected on the cooker hood. A low power level is usually sufficient. Only use the Booster setting when necessary.
 - When a large volume of cooking vapours are being produced, switch to a high power level in good time. This is more efficient than operating the cooker hood for longer to try to capture cooking vapours which have already been distributed throughout the kitchen.
 - Make sure that you switch the cooker hood off after use. If cooking vapours and odours still need to be removed from the kitchen air after cooking, use the run-on function. The fan will switch off automatically after the selected run-on time.

Cleaning and care

 Before proceeding with any maintenance or cleaning task, the cooker hood must be disconnected from the power supply, see “Warning and safety instructions”.

Housing

General information

 The surfaces and controls are susceptible to scratches and abrasion.

Please observe the following cleaning instructions.

- All external surfaces and controls can be cleaned using hot water with a small amount of washing-up liquid applied with a well wrung-out soft sponge or cloth.

 Make sure that water does not get into the cooker hood.

Only clean the area of the controls with a damp cloth.

- Then wipe the surfaces dry using a soft cloth.

Do not use:

- cleaning agents containing soda, acids, chlorides or solvents,
- abrasive cleaning agents, e.g. powder cleaners or cream cleaners and abrasive sponges, as well as pot scourers or sponges which have been used previously with abrasive cleaning agents.

Important for appliances with lacquered housing

- Please observe the general notes on cleaning earlier in this section.

Minor scratches on the surface are inevitable when cleaning the housing. Depending on the lighting in the kitchen, this may negatively affect the appliance's appearance.

Important for the controls

Do not leave soiling on the controls for any length of time.

Otherwise they may suffer discolouration or damage.

Remove soiling straight away.

- Please observe the general notes on cleaning earlier in this section.

Do not use stainless steel cleaning agents on the controls.

Important for appliances with glass surfaces

- Glass surfaces can be cleaned using a proprietary non-abrasive cleaning agent designed specifically for use on glass.

Grease filter(s)



Fire hazard!

An oversaturated grease filter is a fire hazard.

Clean the grease filter(s) at regular intervals.

The re-usable metal grease filter(s) in the appliance remove solid particles from the kitchen vapours (grease, dust, etc) preventing soiling of the cooker hood.

The grease filter(s) must be cleaned at regular intervals.

A heavily soiled grease filter hinders air extraction and will lead to increased levels of soiling in the cooker hood and in the kitchen.

Cleaning interval

Accumulated grease solidifies over a longer period of time and makes cleaning more difficult. The grease filter(s) should therefore be cleaned at least every 3 to 4 weeks.

The filter operating hours control reminds you to regularly clean the grease filters by illuminating the grease filter symbol .

- You can set the operating hours counter interval to suit the type of cooking you do (see “Operation”).

Removing a grease filter



When handling a grease filter, be careful not to drop it.

This can result in damage to the filter and the hob below.

Make sure you hold the filter securely at all times when handling it.

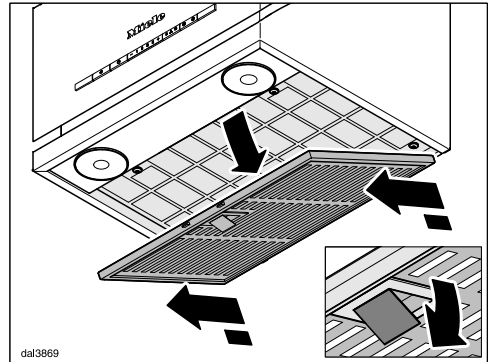

- To take out a grease filter, release the locking clip on the filter, lower the filter approx. 45°, unhook it at the back and remove it.

Cleaning the grease filter by hand

- Clean the filter with a soft nylon brush in a mild solution of hot water and a small amount of washing-up liquid. Do not use “neat” washing up liquid.

Cleaning and care

Unsuitable cleaning agents

Unsuitable cleaning agents can cause damage to the surface of the filters if used regularly.

Do not use:

- cleaning agents containing descaling agents
- powder cleaners, cream cleaners
- aggressive multi-purpose cleaning agents or spray cleaners for grease
- oven sprays

Cleaning the grease filter in a dishwasher

- Place the grease filter upright or slightly inclined in the lower basket. Ensure the spray arm is not obstructed.
- Use a commercially available household dishwasher detergent.
- Select a dishwasher programme with a wash temperature between 50 °C and 65 °C.

Depending on the detergent used, cleaning the grease filter in a dishwasher can cause permanent discolouration to the internal surfaces of the filter. However, this will not affect the functioning of the grease filter in any way.

After cleaning

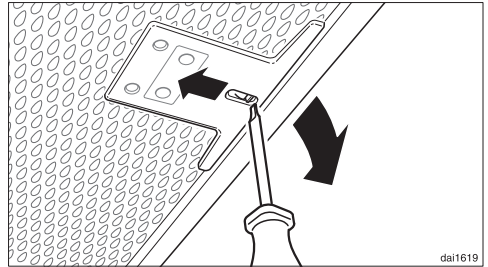

- After cleaning, leave the filter to dry on an absorbent surface before replacing it.
- When removing the filter for cleaning, also clean off any residues of oil or fat from the now accessible casing to prevent the risk of these catching fire.
- Replace the grease filter, making sure that the locking clip is facing outwards.



- If the grease filter is inadvertently replaced the wrong way round, insert a small screwdriver blade into the slit to disengage the clip.



Resetting the grease filter operating hours counter

After cleaning, the operating hours counter needs to be re-set.

- Whilst the fan is switched on, press the operating hours control   for approx. 3 seconds, until only the **1** is flashing.

The Grease filter symbol  goes out.

If you want to clean the grease filter before the operating hours counter has reached its maximum:

- Press the operating hours control   for approx. 6 seconds, until only the **1** is flashing.

Charcoal filter

Recirculation cooker hoods must be fitted with a charcoal filter in addition to the grease filter. This is designed to absorb cooking odours.

It is fitted in the top of the cooker hood.

Fitting/replacing charcoal filters

To fit or replace a charcoal filter the cover at the top of the cooker hood has to be removed. It is held in position by magnets.

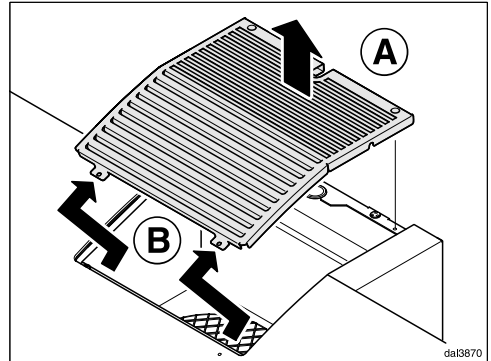

- First lift the cover up at the back and then unhook it at the front.
- Take the charcoal filter out of its packaging.

Cleaning and care

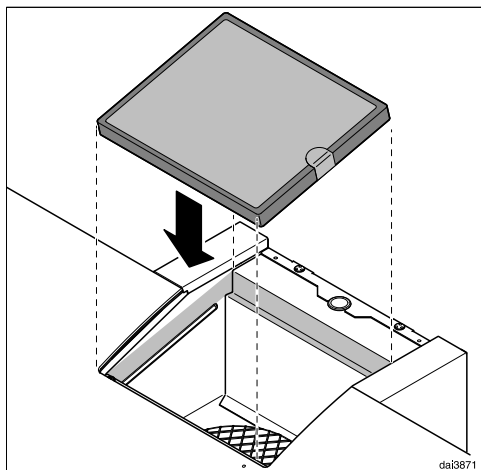

- Fit the charcoal filter into the holder in the top of the cooker hood.
- Refit the cover.

When to change the charcoal filter

- Replace the charcoal filter when it no longer absorbs kitchen odours effectively.

It should, however, be replaced at least every 6 months.

The operating hours counter will remind you to replace the charcoal filter by lighting up the charcoal filter symbol .

Resetting the charcoal filter operating hours counter

After changing the charcoal filter, the operating hours counter needs to be reset.

- To do this, with the fan switched on, press the operating hours control  twice, then hold it for approx. 3 seconds until only the **1** is flashing.

The Charcoal filter symbol  will go out.

If you want to replace the charcoal filter **before** the operating hours counter has reached its maximum:

- Press the operating hours control  twice and hold it for approx. 6 seconds until only the **1** is flashing.

Disposing of charcoal filters

- Used charcoal filters can be disposed of with the normal household waste.

Reactivatable charcoal filter

A reactivatable charcoal filter is available for this cooker hood. By reactivating it in an oven it can be reused several times.

- It is supplied with its own installation and usage instructions which must be observed.

Charcoal filters are available to order via the Miele Webshop, the Miele Spare Parts Department (see end of this booklet for contact details) or from your Miele dealer.

The charcoal filters are listed under “Technical data” at the back of this booklet.

Before installation

 Before installation, it is important to read the information given on the following pages as well as the “Warning and Safety instructions” at the beginning of this booklet.

Installation instructions

See enclosed Installation sheet for instructions on how to install this appliance.

Installation

Assembly parts

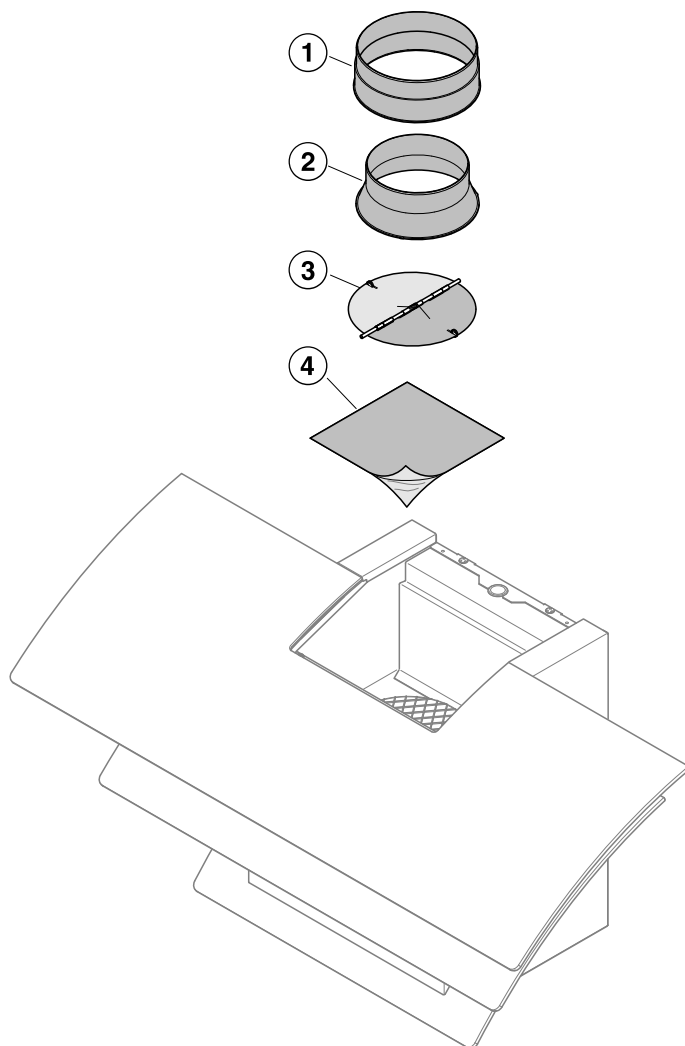

dal3873

- ① **1 exhaust socket**
for exhaust ducting \varnothing 150 mm.
- ② **1 reducing collar**
for exhaust ducting \varnothing 125 mm.
- ③ **1 non-return flap**
for fitting into the exhaust connection on the motor unit (not needed for recirculation mode)
Depending on model, the non-return flap may already be fitted.
- ④ **Cover foil**
for use when changing extraction ducting direction

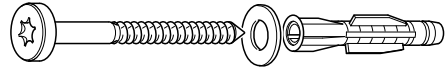

5561-D046B051-531

3 screws 5 x 60 mm and
3 plugs 8 x 50 mm
for securing to the wall.

 The screws and plugs are designed for use in solid walls only. For other types of wall construction, alternative fixings will be required. Make sure the wall is able to take the weight of the cooker hood.

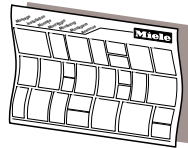

dina3mille

Installation instructions

Installation

Appliance dimensions

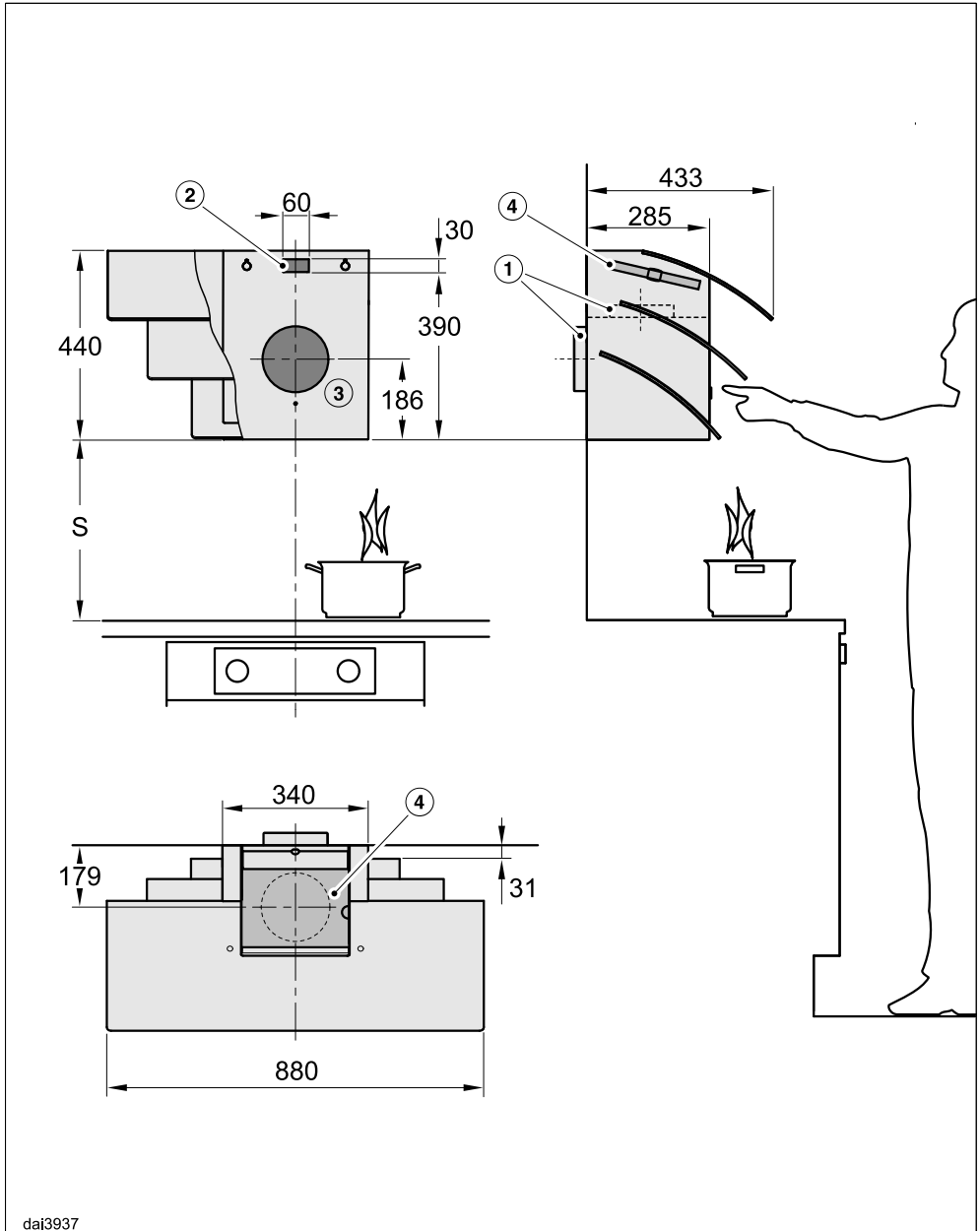

The drawing is not to scale.

- ① Extraction ducting upwards or to the rear.
- ② Cut-out for cooker hoods with hard-wired connection rather than a plug.
- ③ 200 mm \varnothing cut-out ensures sufficient space through the wall for the extraction ducting to flex.
- ④ Ventilation grille for recirculation mode. The distance to the ceiling or to furniture installed above the appliance should be at least 300 mm.

Connection for air extraction \varnothing 150 mm, or \varnothing 125 mm with reducing collar.

Please observe installation positions for the socket and for the ducting outlet shown on the relevant drawings when using the DADC 7000 tower.

Safety distance between hob and cooker hood (S)

When planning the installation height of your cooker hood, the minimum safety distance between the top of a cooker or hob and the bottom of the cooker hood is as follows, unless a greater distance is specified by the manufacturer of your cooking appliance.

See “Warning and Safety” instructions for further information.

Cooking appliance	Minimum distance S
Electric hob	450 mm
Electric grill, deep fat fryer (electric)	650 mm
Multi-burner gas hob, total output \leq 12.6 kW, no burner $>$ 4.5 kW	650 mm
Multi-burner gas hob, total output $>$ 12.6 kW and \leq 21.6 kW, no burner $>$ 4.8 kW.	760 mm
Multi-burner gas hob, total output $>$ 21.6 kW, or multi-burner gas hob where one burner $>$ 4.8 kW.	Not possible
Single burner gas hob, output \leq 6 kW.	650 mm
Single burner gas hob, output $>$ 6 kW and \leq 8.1 kW.	760 mm
Single burner gas hob, output $>$ 8.1 kW	Not possible

Installation

Installation recommendations

- Account should also be taken of the height of the person who will be using the hood most often. They should have sufficient space to work comfortably at the hob, and be able to reach the cooker hood controls with ease.
- Please be aware that if positioned too high, extraction will be inefficient.
- To achieve optimum vapour extraction, the cooker hood must be positioned centrally over the hob, not to the side.
- The hob should be no wider than the cooker hood, and if possible, it should be narrower.
- The installation area must be easily accessible. The cooker hood should be easily accessible and easy to dismantle in the event that service is required. This should be taken into consideration when planning the position of cupboards, shelves, ceilings or features in the vicinity of the cooker hood.

Drilling diagram for wall mounting

- When drilling, please follow the directions contained on the accompanying installation sheet.

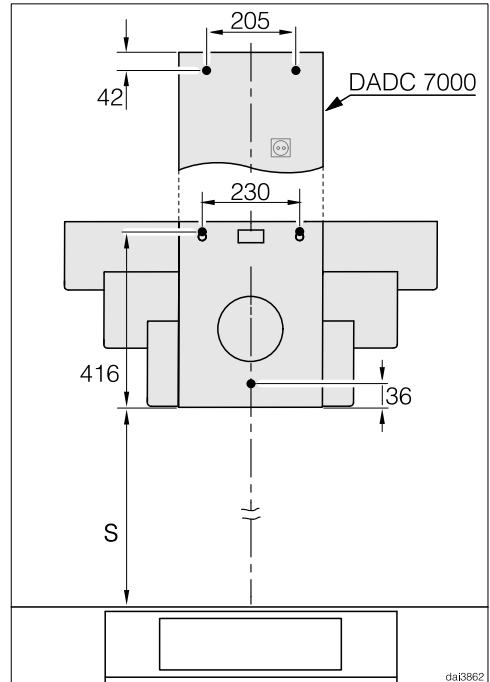

- When installing a custom back wall with pre-drilled holes, please refer to the drilling distances in the drawing above (screws \varnothing 5 mm).

Connection for air extraction

⚠ If the cooker hood is used at the same time as a heating appliance that relies on oxygen from the same room, there is a risk in certain circumstances of toxic fumes building up.

It is essential that the “Warning and Safety” instructions are observed. The cooker hood should be installed according to local and national building regulations. Seek approval from the building inspector where necessary.

Use smooth pipes or flexible ducting made from approved non-flammable materials for exhaust ducting.

When using an external motor, make sure that the exhaust ducting is sufficiently rigid. The external motor can cause an underpressure which can result in the exhaust ducting distorting.

To achieve the most efficient air extraction with the lowest noise levels, please note the following:

- The diameter of the exhaust ducting should not be less than 150 mm.
 - If flat ducting is being used, the cross section must not be smaller than the cross sectional area of the exhaust connection.
 - The exhaust ducting should be as short and straight as possible.
 - Only use wide radius bends.
 - The exhaust ducting must not be kinked or compressed.
- Ensure that all connections are strong and airtight.

Remember that any constriction of the air flow will reduce extraction performance and increase operating noise.

- If the exhaust is ducted through an outside wall, a telescopic wall vent or a roof vent (available as an optional accessory) is recommended.

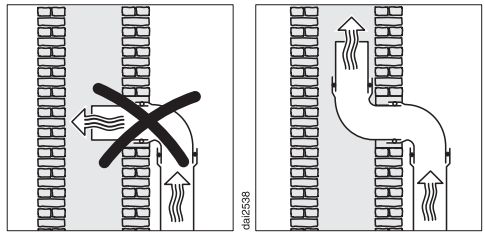

- If the exhaust air is to be ducted into a flue, the ducting must be directed in the flow direction of the flue.
- Where ducting is horizontal, it must be laid to slope away at at least 1 cm per metre. This is to ensure that condensate cannot drain back into the cooker hood.
- If the exhaust ducting is to run through rooms, ceiling space etc. there may be great variations in temperature between the different areas. The problem of condensation will need to be addressed. The exhaust ducting will need to be suitably insulated.

Connection for air extraction

Condensate trap

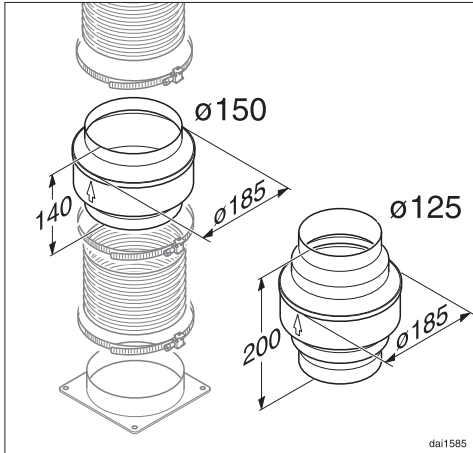

In addition to insulating the exhaust ducting, we recommend that a suitable condensate trap is also installed to collect and evaporate any condensate which may occur.

Condensate traps for 125 mm or 150 mm ducting are available as optional accessories.

A condensate trap can only be fitted in extraction ducting which is directed upwards out of the cooker hood.

- When installing a condensate trap, ensure that it is positioned vertically and as closely as possible above the exhaust socket. The arrow on the housing indicates the direction of air-flow.

A condensate trap is integrated in cooker hoods which are designed for connection to an external motor (model.....EXT).

Silencer

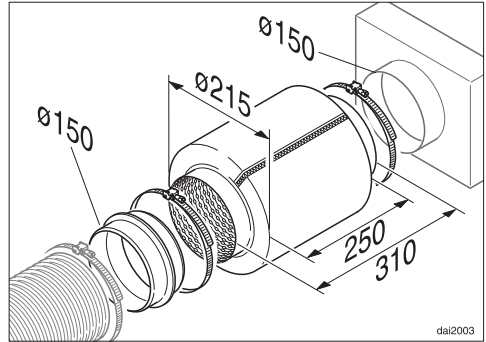

To achieve even further reductions in noise levels, a special silencer (optional accessory) can be fitted in the ducting system.

Extraction mode

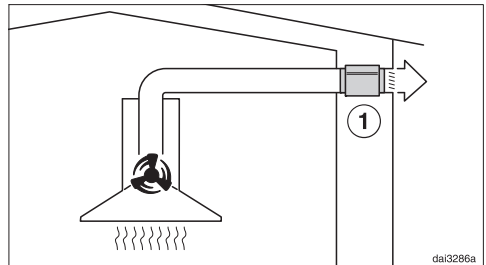

The silencer not only reduces noise from the motor outside the house, but also sounds from outside (e.g. traffic noise). For this reason the silencer must be positioned as close as possible to the ducting exit ①.

Extraction mode with external motor

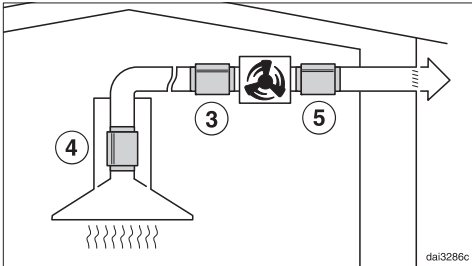

To minimise noise from the motor in the kitchen, the silencer should be positioned in front of the external motor ③ if possible, or, if the ducting is long, above the exhaust socket on the cooker hood ④. In the case of an external motor located inside the house, fitting a silencer behind the external motor ⑤ reduces the noise of the motor outside the house.

Electrical connection

 Installation, repairs and other work by unqualified persons could be dangerous. The manufacturer cannot be held liable for unauthorised work.

All electrical work should be undertaken by a suitably qualified and competent person in strict accordance with current national and local safety and building regulations.

The connection data is given on the data plate (See “After sales service”). Ensure that this data matches the voltage and frequency of the household mains supply.

This cooker hood must only be connected to a properly installed electrical circuit.

The electrical installation must comply with national regulations (BS 7671 in the UK).

For extra safety, it is advisable to protect the appliance with a suitable residual current device (RCD) with a trip range of 30 mA (DIN VDE 0664).

It is advisable to connect this appliance via a suitable plug and socket to make it easy to disconnect for servicing purposes. The socket and switch must be easily accessible after the appliance has been installed.

Alternatively it can be hard-wired.

If the mains socket and switch are not accessible after the appliance has been installed, or if it is hard-wired, a separator for each terminal must be present. There must be an all-pole contact gap of at least 3 mm in the switch.

This includes the switch, fuses and relays (in accordance with EN 60335).

In the event of a fault which you cannot remedy yourself, please contact your Miele dealer or the Miele Service Department.

Contact details for Miele are given at the end of this booklet. N.B. A call-out fee will be charged for service visits where the problem could have been resolved as described in these instructions.

When contacting your dealer or Miele, please quote the model and serial number of your appliance. These are shown on the data plate.

Position of the data plate

The data plate is visible after removing the grease filter.

Warranty: U.K.

In the U.K., the appliance warranty is valid for 2 years from the date of purchase. However, you must activate your cover by calling 0330 160 6640 or registering online at www.miele.co.uk.

Please note that telephone calls may be monitored and recorded for training purposes.

Warranty: Other countries

For information on the appliance warranty specific to your country please contact Miele. See end of this booklet for contact details.

Technical data

Fan motor*	105 W
Hob lighting	2 x 3 W
Total connected load*	111 W
Voltage, frequency	AC 230 V, 50 Hz
Fuse rating	5 A
Mains connection cable length	1.5 m
Weight	
DA 7198 W	21 kg
DA 7198 W EXT	18 kg

* For EXT models, the rated load will depend on the type of external motor fitted.
Length of connection cable to external motor: 1.7 m

WiFi module

Frequency band	2.412 - 2.462 GHz
Maximum transmitting power	< 100 mW

Wireless module (ZigBee)

Frequency band	2.405 - 2.48 GHz
Maximum transmitting power	< 10 mW

Accessory required for recirculation mode

Charcoal filter DKF 11-1 or DKF 11-R (reactivatable).

Conformity declaration

Miele hereby declares that this cooker hood complies with Directive 2014/53/EU.

The complete text of the EU declaration of conformity is available from one of the following internet addresses:

- Products, Download from www.miele.co.uk
- For service, information, operating instructions etc: go to www.miele.co.uk/domestic/customer-information-385.htm and enter the name of the product or the serial number

Note for test institutes

All information required regarding measuring noise levels is given in the **“Testing for sound emissions”** leaflet.

The latest version of this leaflet can be ordered by email from:

- testinfo@miele.de

Please quote your postal address, as well as the model and serial number of your cooker hood (see data plate).

Note for test institutes

Data quoted in the following data sheets was calculated in accordance with the following standards EN 61591 and EN 60704-3. The distance between the area being measured/hob and the underside of the cooker hood is 600 mm and the voltage 230 V for test purposes. Testing is carried out without a non-return valve.

Energy efficiency must be calculated using extraction mode. The cooker hood is set up ex-works for recirculation mode. To re-set it for extraction mode the operating hours counter for the charcoal filter(s) has to be deactivated (see “Before using for the first time”).

Technical data

Data sheet for household cooker hoods

In acc. with delegated regulation (EU) No. 65/2014 and regulation (EU) No. 66/2014

MIELE	
Model name/identifier	DA 7198 W
Annual Energy Consumption (AEC_{hood})	26,0 kWh/year
Energy efficiency class	A+
Energy efficiency index (EEl_{hood})	41,9
Fluid Dynamic Efficiency (FDE_{hood})	34,7
Fluid Dynamic Efficiency class	
A (most efficient) to G (least efficient)	A
Lighting Efficiency (LE_{hood})	100,0 lx/W
Lighting Efficiency class	
A (most efficient) to G (least efficient)	A
Grease Filtering Efficiency	89,3%
Grease Filtering Efficiency class	
A (most efficient) to G (least efficient)	B
Airflow at best efficiency point	278,3 m ³ /h
Air flow (min. speed)	160 m ³ /h
Air flow (max. speed)	375 m ³ /h
Air flow (intensive or boost setting)	600 m ³ /h
Max. air flow (Q_{max})	600 m ³ /h
Air pressure at best efficiency point	355 Pa
Airborne acoustical A-weighted sound power emissions (min. speed)	40 dB
Airborne acoustical A-weighted sound power emissions (max. speed)	60 dB
Airborne acoustical A-weighted sound power emissions (intensive or boost setting)	72 dB
Electrical power input at best efficiency point	79,0 W
Power consumption in off mode (P_o)	W
Power consumption in standby mode (P_s)	0,35 W
Nominal power of lighting system	6,0 W
Average illumination of the lighting system on the cooking surface	600 lx
Time increase factor	0,7

Data sheet for household cooker hoods

In acc. with delegated regulation (EU) No. 65/2014 and regulation (EU) No. 66/2014

MIELE	
Model name/identifier	DA 7198 W EXT
Annual Energy Consumption (AEC_{hood})	4,4 kWh/year
Energy efficiency class	A++
Energy efficiency index (EEl_{hood})	23,5
Fluid Dynamic Efficiency (FDE_{hood})	
Fluid Dynamic Efficiency class	
A (most efficient) to G (least efficient)	-
Lighting Efficiency (LE_{hood})	100,0 lx/W
Lighting Efficiency class	
A (most efficient) to G (least efficient)	A
Grease Filtering Efficiency	%
Grease Filtering Efficiency class	
A (most efficient) to G (least efficient)	-
Airflow at best efficiency point	m^3/h
Air flow (min. speed)	m^3/h
Air flow (max. speed)	m^3/h
Air flow (intensive or boost setting)	m^3/h
Max. air flow (Q_{max})	m^3/h
Air pressure at best efficiency point	Pa
Airborne acoustical A-weighted sound power emissions (min. speed)	dB
Airborne acoustical A-weighted sound power emissions (max. speed)	0 dB
Airborne acoustical A-weighted sound power emissions (intensive or boost setting)	dB
Electrical power input at best efficiency point	W
Power consumption in off mode (P_o)	W
Power consumption in standby mode (P_s)	0,35 W
Nominal power of lighting system	6,0 W
Average illumination of the lighting system on the cooking surface	600 lx
Time increase factor	



United Kingdom

Miele Co. Ltd.
Fairacres, Marcham Road
Abingdon, Oxon, OX14 1TW
Tel: 0330 160 6600
Internet: www.miele.com

Australia

Miele Australia Pty. Ltd.
ACN 005 635 398
ABN 96 005 635 398
1 Gilbert Park Drive
Knoxfield, VIC 3180
Tel: 1300 464 353
Internet: www.miele.com.au

China

Miele (Shanghai) Trading Ltd.
1-3 Floor, No. 82 Shi Men Yi Road
Jing' an District
200040 Shanghai, PRC
Tel: +86 21 6157 3500
Fax: +86 21 6157 3511
E-mail: info@miele.cn
Internet: www.miele.cn

Miele (Hong Kong) Limited

41/F - 4101, Manhattan Place
23 Wang Tai Road
Kowloon Bay, Hong Kong
Tel: (852) 2610 1025
Fax: (852) 3579 1404
Email:
customerservices@miele.com.hk
Website: www.miele.hk

India

Miele India Pvt. Ltd.
Ground Floor
Copia Corporate Suites
Plot No. 9, Jasola
New Delhi - 110025
Tel: 011-46 900 000
Fax: 011-46 900 001
E-mail: customercare@miele.in
Internet: www.miele.in

Ireland

Miele Ireland Ltd.
2024 Bianconi Avenue
Citywest Business Campus
Dublin 24
Tel: (01) 461 07 10
Fax: (01) 461 07 97
E-Mail: info@miele.ie
Internet: www.miele.ie

Malaysia

Miele Sdn Bhd
Suite 12-2, Level 12
Menara Sapura Kencana
Petroleum
Solaris Dutamas No. 1
Jalan Dutamas 1
50480 Kuala Lumpur, Malaysia
Phone: +603-6209-0288
Fax: +603-6205-3768

New Zealand

Miele New Zealand Limited
IRD 98 463 631
Level 2, 10 College Hill
Freemans Bay, Auckland 1011
New Zealand
Tel: 0800 464 353
Internet: www.miele.co.nz

Singapore

Miele Pte. Ltd.
163 Penang Road
04 - 03 Winsland House II
Singapore 238463
Tel: +65 6735 1191
Fax: +65 6735 1161
E-Mail: info@miele.com.sg
Internet: www.miele.sg

South Africa

Miele (Pty) Ltd
63 Peter Place, Bryanston 2194
P.O. Box 69434, Bryanston 2021
Tel: (011) 875 9000
Fax: (011) 875 9035
E-mail: info@miele.co.za
Internet: www.miele.co.za

Taiwan

K.E. & Kingstone Co., Ltd.
6th Fl., No. 120, Sec. 2
Jianguo N. Rd.
Taipei, Taiwan
TEL: +886 2 2502-7256
FAX: +886 2 2502-3077
E-mail: kenk@kenk.com.tw
Website:
www.kenk.com.tw/ke/miele

Thailand

BHIRAJ TOWER at EmQuartier
43rd Floor Unit 4301-4303
689 Sukhumvit Road
North Klongton Sub-District
Vadhana District
Bangkok 10110, Thailand

United Arab Emirates

Miele Appliances Ltd.
Gold & Diamond Park
Office No. 6-217
Sheikh Zayed Road
P.O. Box 11 47 82 - Dubai
Tel. +971 4 3044 999
Fax. +971 4 3418 852
800-MIELE (64353)
E-Mail: info@miele.ae
Website: www.miele.ae

Manufacturer: Miele & Cie. KG, Carl-Miele-Straße 29, 33332 Gütersloh, Germany

DA 7198 W,
DA 7198 W EXT