

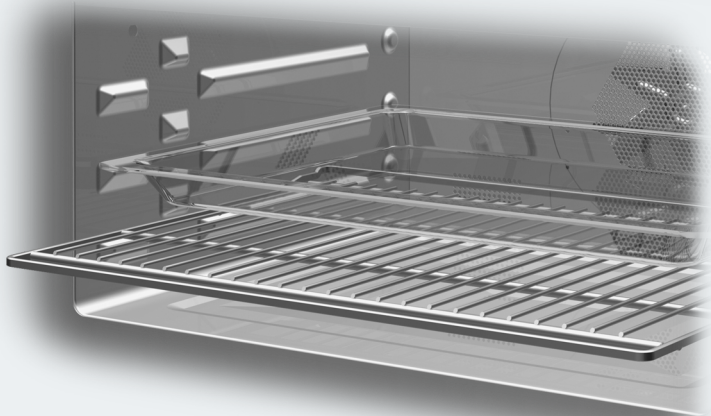

## Operating and installation instructions Microwave combination oven



To avoid the risk of accidents or damage to the appliance it is **essential** to read these instructions before it is installed and used for the first time.

# Contents

---

<b>Warning and safety instructions</b> .....	5
<b>Caring for the environment</b> .....	16
<b>Guide to the appliance</b> .....	17
<b>Controls</b> .....	18
On/Off sensor control .....	19
Display .....	19
Sensor controls .....	19
Symbols .....	21
<b>Using the appliance</b> .....	22
Selecting a menu option .....	22
Changing a setting in a list .....	22
Changing the setting with a segment bar .....	22
Selecting a function or operating mode .....	23
Entering numbers .....	23
Activating MobileStart .....	23
<b>Features</b> .....	24
Data plate .....	24
Scope of delivery .....	24
Accessories supplied and available to order .....	24
Safety features .....	27
PerfectClean treated surfaces .....	27
<b>Before using for the first time</b> .....	28
Miele@home .....	28
Basic settings .....	29
Heating up the oven for the first time .....	30
<b>Settings</b> .....	31
Settings overview .....	31
Opening the “Settings” menu .....	33
Language  .....	33
Time .....	33
Lighting .....	34
Display .....	34
Volume .....	34
Units .....	35
Quick MW .....	35
Popcorn .....	35
Booster .....	35
Recommended temps. ....	35
Recommend. power levels .....	36
Cooling fan run-on .....	36
Safety .....	37
Miele@home .....	37
RemoteUpdate .....	38

---

Remote control.....	39
Activating MobileStart.....	39
Software version.....	39
Showroom programme.....	39
Factory default.....	39
<b>Min. minder</b> .....	40
<b>Main and sub-menus</b> .....	41
<b>Microwave operation</b> .....	42
How it works.....	42
Selecting crockery.....	42
Suitable crockery.....	43
Unsuitable crockery.....	45
Testing dishes.....	46
Cover.....	47
<b>Operation</b> .....	48
Changing values and settings for a cooking programme.....	48
Changing the temperature.....	49
Changing the microwave power level.....	49
Setting cooking durations.....	49
Changing the set cooking durations.....	50
Deleting the set cooking durations.....	50
Interrupting a cooking programme in the Microwave function.....	50
Cancelling a cooking programme.....	51
Pre-heating the oven compartment.....	51
Booster.....	51
<b>Quick MW and Popcorn</b> .....	52
<b>Automatic programmes</b> .....	53
Categories.....	53
Using automatic programmes.....	53
Handy hints.....	53
<b>Further applications</b> .....	54
Defrost.....	54
Drying.....	56
Reheating.....	57
Cooking.....	60
Frozen food/Ready meals.....	62
Heat crockery.....	62
<b>Baking</b> .....	63
Tips on baking.....	63
Notes on the cooking charts.....	63
Notes on the functions.....	64
<b>Roasting</b> .....	65
Tips for roasting.....	65

# Contents

---

Notes on the cooking charts .....	65
Notes on the functions .....	66
<b>Grilling</b> .....	67
Tips for grilling .....	67
Notes on the cooking charts .....	67
Notes on the functions .....	68
<b>Cleaning and care</b> .....	69
Unsuitable cleaning agents .....	69
Removing normal soiling .....	70
Removing stubborn soiling .....	70
Lowering the grill element .....	71
<b>Problem solving guide</b> .....	72
<b>Service</b> .....	76
Contact in the event of a fault .....	76
Warranty .....	76
<b>Installation</b> .....	77
Installation dimensions .....	77
Installation in a tall or base unit .....	77
Side view .....	78
Connections and ventilation .....	79
Installing the oven .....	80
Electrical connection .....	81
<b>Cooking charts</b> .....	82
Batter .....	82
Shortcrust pastry .....	83
Yeast dough .....	84
Quark dough .....	84
Sponge mixture .....	85
Choux pastry, puff pastry, meringue .....	85
Savoury dishes .....	86
Beef .....	87
Veal .....	87
Pork .....	88
Lamb, game .....	89
Poultry, fish .....	90
<b>Notes for test institutes</b> .....	91
Test food according to EN 60350-1 .....	91
Test food in accordance with EN 60705 (microwave operating mode  ) .....	92
<b>Conformity declaration</b> .....	93
EU Conformity declaration .....	93
UK Conformity declaration .....	93
<b>Copyrights and licences for the communication module</b> .....	94

## Warning and safety instructions

---

► For the sake of simplicity, the microwave combination oven will subsequently be referred to as the “oven”.

This oven complies with all current local and national safety requirements. However, inappropriate use can lead to personal injury and damage to property.

Read the operating and installation instructions carefully before using the oven. They contain important information on safety, installation, use and maintenance. This prevents both personal injury and damage to the oven.

In accordance with standard IEC/EN 60335-1, Miele expressly and strongly advises that you read and follow the instructions in the chapter on installing the oven as well as the safety instructions and warnings.

Miele cannot be held liable for damage caused by non-compliance with these instructions.

Keep these instructions in a safe place and pass them on to any future owner.

### Appropriate use

► This oven is intended for domestic use and use in other similar environments.

► The oven is not intended for outdoor use.

► It is intended for cooking food – and, in particular, for baking, roasting, grilling, reheating, defrosting and drying food – in domestic settings only.

All other types of use are not permitted.

► Fire hazard due to flammable materials.

If flammable items are dried using microwave power, the moisture in the items will evaporate. This could cause the materials to dry out and possibly self-ignite.

Never use the oven to store or dry items which could ignite easily.

## Warning and safety instructions

---

▶ This oven may only be used by people with reduced physical, sensory or mental capabilities or lack of experience and knowledge if they are supervised whilst using it.

They may only use it unsupervised if they have been shown how to use it in a safe manner. They must be able to recognise and understand the dangers of misuse.

▶ The oven compartment is equipped with special lamps to cope with particular conditions (e.g. temperature, moisture, chemical resistance, abrasion resistance and vibration). These special lamps must only be used for the purpose for which they are intended. They are not suitable for room lighting. Replacement lamps may only be fitted by a Miele authorised technician or by the Miele Customer Service Department.

▶ The oven contains 1 light source corresponding to energy efficiency class F.

### Safety with children

▶ Activate the system lock to ensure that children cannot switch on the steam oven inadvertently.

▶ Children under 8 years of age must be kept away from the oven unless they are constantly supervised.

▶ Children aged 8 and older may only use the oven without supervision if they have been shown how to use it in a safe manner. Children must be able to understand and recognise the possible dangers caused by incorrect operation.

▶ Children must not be allowed to clean or maintain the oven unsupervised.

▶ Children should be supervised in the vicinity of the oven. Never allow children to play with the oven.

▶ Risk of suffocation due to packaging material. Whilst playing, children may become entangled in packaging material (such as plastic wrapping) or pull it over their head, presenting the risk of suffocation. Keep packaging material away from children.

## Warning and safety instructions

---

▶ Risk of injury caused by hot surfaces. Children's skin is far more sensitive to high temperatures than that of adults. External parts of the oven such as the door glass, control panel and the vent become quite hot.

Do not let children touch the oven when it is in operation.

▶ Risk of injury from the open door.

The oven door can support a maximum weight of 8 kg. Children could injure themselves on an open door.

Do not let children sit on the open door, lean against it or swing on it.

### Technical safety

▶ Unauthorised installation, maintenance and repairs can cause considerable danger for the user. Installation, maintenance and repairs must only be carried out by a Miele authorised technician.

▶ Temporary or permanent operation on an autonomous power supply system or a power supply system that is not synchronised with the mains power supply (e.g. island networks, back-up systems) is possible. A prerequisite for operation is that the power supply system complies with the specifications of EN 50160 or an equivalent standard.

The function and operation of the protective measures provided in the domestic electrical installation and in this Miele product must also be maintained in isolated operation or in operation that is not synchronised with the mains power supply, or these measures must be replaced by equivalent measures in the installation. As described, for example, in the current version of BS OHSAS 18001-2 ISO 45001.

▶ Damage to the oven can compromise your safety. Check the oven for visible signs of damage. Do not use a damaged oven.

▶ Operating a damaged oven can result in microwave leakage and present a hazard to the user. Do not use the oven if:

- the door is warped.
- the door hinges are loose.
- holes or cracks are visible in the casing, the door or the oven compartment walls.

## Warning and safety instructions

---

- ▶ The electrical safety of this oven can only be guaranteed when correctly earthed. It is most important that this basic safety requirement is fulfilled. If in doubt, the electrical installation should be checked by a qualified electrician.
- ▶ The connection data (voltage and frequency) on the data plate of the oven must match the mains electricity supply in order to avoid the risk of damage to the oven. Compare this before connecting the appliance to the mains. If in any doubt, consult a qualified electrician.
- ▶ Multi-socket adapters and extension leads do not guarantee the required safety of the appliance. Do not use these to connect the oven to the mains electricity supply.
- ▶ For safety reasons, the oven may only be used when it has been built in and fully installed.
- ▶ The oven must not be used in a non-stationary location (e.g. on a ship).
- ▶ Risk of injury due to electric shock. Any contact with live connections or tampering with the electrical or mechanical components of the oven will endanger your safety and may lead to the oven malfunctioning.  
Do not open the oven housing under any circumstances.
- ▶ While the oven is under warranty, repairs should only be undertaken by a Miele authorised service technician. Otherwise the warranty will be invalidated.
- ▶ Miele can only guarantee the safety of the oven when original Miele spare parts are used. Faulty components must only be replaced by original spare parts.
- ▶ If the oven is delivered without a power connection cable, a special cable must be installed by a Miele authorised service technician (see “Installation”, “Electrical connection”).
- ▶ If the connection cable is damaged, it must be replaced with a special connection cable by a Miele authorised service technician (see “Installation”, “Electrical connection”).



## Warning and safety instructions

---



- ▶ During installation, maintenance and repair work, the oven must be completely disconnected from the mains electricity supply. To ensure this:
  - disconnect the mains fuse, or
  - completely unscrew the screw-out fuse (in countries where this is applicable), or
  - pull out the plug (if one is present) at the wall socket. To do this, pull the plug and not the mains connection cable.
- ▶ The oven requires a sufficient supply of cool air for efficient operation. Make sure that the supply of cool air is not hindered in any way (e.g. by fitting heat insulation strips in the housing unit). Furthermore, the required supply of cool air must not be excessively heated by other heat sources (e.g. solid fuel stoves).
- ▶ If the oven is built in behind a furniture front (e.g. a door), do not close the furniture door while the oven is in use. Heat and moisture can build up behind the closed furniture door. This can result in damage to the oven, housing unit and floor. Leave the furniture front/door open until the oven has cooled down completely.

### Correct use

- ▶ Risk of injury caused by hot surfaces. The oven gets hot during operation. You could burn yourself on the heating elements, oven compartment, accessories or food.  
Wear oven gloves when placing hot food in the oven or removing it and when adjusting oven shelves, for example, in a hot oven compartment.
- ▶ To avoid fuelling any flames, do not open the oven door if smoke occurs inside the appliance. Interrupt the process by switching the appliance off and disconnect it from the mains electricity supply. Do not open the door until the smoke has dispersed.
- ▶ Due to the high temperatures radiated, objects left near the oven could catch fire. Do not use the oven to heat up the room.

## Warning and safety instructions

---



- ▶ Oils and fats can ignite if allowed to overheat. Never leave the oven unattended when cooking with oil or fats. Never attempt to put out oil or fat fires with water. Switch the oven off and extinguish the flames by leaving the door closed.
- ▶ Grilling food for excessively long cooking durations can cause it to dry out with the risk of catching fire. Do not exceed the recommended cooking durations.
- ▶ Please be aware that durations when using microwave power are often considerably shorter when cooking, reheating and defrosting than when using functions without microwave power. Excessively long cooking times can lead to food drying out and burning, or could even cause it to catch fire.  
Do not exceed recommended grilling times when using grill functions. Do not use the Microwave  function to dry flowers or herbs or to crisp up bread or rolls. Never use grill functions to dry flowers, herbs or the like. Use the Fan plus  function and always ensure this type of procedure is supervised.
- ▶ If using alcohol in your recipes, please be aware that high temperatures can cause the alcohol to evaporate. The vapour can catch fire on hot heating elements.
- ▶ When using residual heat to keep food warm, corrosion from high air humidity and condensation can occur in the oven. This can also cause damage to the control panel, worktop and surrounding kitchen furniture. Keep the oven on and select the lowest temperature available for the selected function. The cooling fan will then continue to run automatically.
- ▶ Food which is stored in the oven compartment or left in it to be kept warm can dry out and the moisture released can lead to corrosion damage in the oven. Always cover food that is left in the oven to keep warm.

## Warning and safety instructions

---

▶ A build-up of heat can cause damage to the oven.

Never line the floor of the oven compartment with aluminum foil or oven liners.

If you wish to place crockery on the floor of the oven compartment during cooking, or place crockery on the floor of the oven compartment to heat it up, you can do so, but only with the Fan plus  or Eco Fan heat  function, without the Booster function.

▶ The oven compartment floor can become damaged by items being pushed around on it. When placing pots, pans or crockery on the oven compartment floor, ensure that you avoid pushing them around.

▶ Risk of injury caused by steam. Pouring a cold liquid onto a hot surface creates steam, which can cause severe scalding. The sudden temperature change can also cause damage to hot enamelled surfaces. Never pour cold liquids directly onto hot enamelled surfaces.

▶ The oven is not suitable for cleaning or disinfecting items. Items can get extremely hot and there is a risk of burning when the item is removed from the oven.

▶ It is important that the temperature in the food being cooked is evenly distributed and sufficiently high.

This can be achieved by stirring or turning the food, and observing a sufficiently long standing time (see charts), which should be added to the time needed for reheating, defrosting or cooking.

During the standing time, the temperature is distributed evenly in the food.

## Warning and safety instructions

---

▶ When heating food, and in particular liquids, using the Microwave  function, the boiling point may be reached without the production of typical bubbles. The liquid does not boil evenly throughout. This boiling delay can result in the liquid boiling over explosively. Take care when taking the container out of the oven, as the hot liquid can cause severe scalding. Under certain circumstances, the pressure can be so high that the door opens automatically.

Stir liquids well before heating. After heating, wait at least 20 seconds before removing the container from the oven compartment. In addition, a glass rod or similar item, if available, can be placed in the container during heating.

▶ Risk of injury caused by hot food. When heating food up, the heat is created directly in the food itself. For this reason the crockery will remain cooler than the food (except when using oven-proof stoneware). The crockery is only warmed by the heat of the food. Before serving, always check the temperature of the actual food itself after taking it out of the oven. The temperature of the container is not an indication of the temperature of the food or liquid in it. **This is particularly important when preparing food for babies, children, and the elderly or infirm.** After reheating food, especially food for babies and small children, stir the food or shake the container and check that the temperature does not pose any danger of burning. Double check after it has been left to stand.

▶ Risk of injury from increased pressure in closed containers or bottles. Pressure can build up during reheating in sealed containers or bottles, causing them to explode.

Never cook or reheat food or liquids in sealed containers or bottles. Open containers beforehand. In the case of baby bottles, the screw top and teat must be removed.

▶ If you cook eggs without their shells, the yolks could explode due to the resulting pressure.

Prick the yolk several times before cooking to avoid this.

## Warning and safety instructions

---

▶ Eggs heated in their shells can burst, even after they have been taken out of the oven compartment.

Eggs can only be cooked in their shells in a specially designed egg-boiling device. Do not reheat hard boiled eggs using the Microwave  function.

▶ Food with a thick skin or peel, such as tomatoes, sausage, potatoes and aubergines can burst when heated or cooked.

Pierce or score the skin of these types of food several times to allow steam to escape.

▶ Do not use thermometers containing mercury or liquid as these are not suitable for use with very high temperatures and break very easily.

To check food temperature, first interrupt the cooking process. Only use a thermometer specifically approved for food use to measure the temperature of the food.

▶ Cushions or pads filled with cherry kernels, gel, etc., such as those used in aromatherapy, can ignite when heated even after they have been removed from the oven compartment.

Do not heat these up in the oven.

▶ Containers and lids with hollow handles or knobs can collect moisture in the hollow spaces. When the moisture evaporates, pressure can build up and the item can explode. If the hollow recess is sufficiently ventilated, the item can be used.

Do not use crockery with hollow knobs or handles when using the Microwave  function.

▶ Non-microwave-safe plastic dishes can suffer damage or damage the oven if used with the Microwave  function and microwave functions.

Do not use any crockery or cutlery made from or containing metal, aluminium foil, lead crystal glassware, temperature-sensitive plastics, wooden utensils or cutlery, metal clips, or plastic or paper-covered wire ties. Do not use bowls with milled rims, or plastic pots with the foil lid only partially removed (see the requirements specified for crockery in the section on microwave operation).

## Warning and safety instructions

---

▶ Plastic dishes that are not suitable for use in an oven will melt and may ignite at high temperatures, and can damage the oven. Use only plastic dishes that are suitable for use in an oven when using functions that do not use microwave power. Follow the manufacturer's instructions.

▶ Fire hazard due to containers made of flammable materials. Plastic disposable containers must meet the requirements specified for crockery in the section on microwave operation. Do not leave the oven unattended when heating or cooking food in disposable containers made of plastic, paper or other inflammable materials.

▶ Heat-retaining bags usually contain a thin layer of aluminium foil that reflects microwave radiation. This reflected energy can, in turn, cause the outer paper covering to become so hot that it ignites. Do not use heat-retaining packaging, such as bags for grilled chicken, for warming food with functions that use microwave power.

▶ If the oven is used without food or the food is loaded incorrectly when using the Microwave  operating mode or operating modes that use microwave power, the oven can become damaged.

**Always** use the glass tray with the Microwave  operating mode, even if you use it as a container for smaller dishes.

Do not use any operating modes that use microwave power to pre-heat crockery or to dry herbs.

Instead, use the Fan plus  operating mode.

▶ Heating up food in closed containers, such as tins or sealed jars, will result in an increase in pressure, which can cause them to explode. Do not heat up unopened tins or jars of food in the oven.

▶ Risk of injury from the open door. You could bang into the open door or trip over it. Avoid leaving the door open unnecessarily.

▶ The door can support a maximum load of 8 kg. Do not lean or sit on an open door, or place heavy items on it. Make sure that nothing gets trapped between the door and the oven compartment. This could damage the oven.

# Warning and safety instructions

---

## The following applies to stainless steel surfaces:

- ▶ Adhesives will damage the stainless steel surface and cause it to lose its dirt-repellent protective coating. Do not use sticky notes, adhesive tape or other types of adhesive on the stainless steel surface.
- ▶ Magnets can cause scratches. Do not use the stainless steel surface as a magnetic notice board.

## Cleaning and care

- ▶ Risk of injury due to electric shock. The steam from a steam cleaning appliance could reach live electrical components and cause a short circuit. Do not use a steam cleaner to clean the appliance.
- ▶ Scratches on the door glass can cause the glass to break. Do not use abrasive cleaners, hard sponges, brushes or sharp metal tools to clean the door glass.
- ▶ Try to prevent the interior walls being splashed with food containing salt. If this does happen, wipe it away thoroughly to avoid corrosion to stainless steel surfaces inside the oven compartment.
- ▶ In warm, moist environments, there is a higher probability of pest infestations (such as cockroaches). Ensure the oven and the area surrounding it are always kept clean.  
Damage caused by pests is not covered by the warranty.

## Accessories

- ▶ Only use original Miele accessories. If other parts are used, warranty, performance and product liability claims will be invalidated.
- ▶ Miele will guarantee to supply functional spare parts for a minimum of 10 years and up to 15 years following the discontinuation of your oven.

# Caring for the environment

---

## Disposing of the packaging material

The packaging material is used for handling and protects the appliance from transport damage. The packaging material used is selected from materials which are environmentally friendly for disposal and can generally be recycled.

Recycling the packaging material reduces the use of raw materials. Use material-specific collection points for valuable materials and take advantage of return options. Your Miele dealer will take the packaging material away.

## Disposing of your old appliance

Electrical and electronic appliances contain many valuable materials. They also contain certain materials, compounds and components which were essential for their correct functioning and safety. These could be hazardous to human health and to the environment if disposed of with household waste or if handled incorrectly. Please do not, therefore, dispose of your old appliance with household waste.



Instead, please make use of officially designated collection and disposal points to dispose of and recycle electrical and electronic appliances in your local community, with your dealer or with Miele, free of charge. By law, you are solely responsible for deleting any personal data from the old appliance prior to disposal. You are legally obliged to remove any old batteries which are not securely enclosed by the appliance and to remove any lamps without destroying them, where this is possible. These must be taken to a suitable collection point where they can be handed in free of charge. Please ensure that your old appliance poses no risk to children while being stored for disposal.





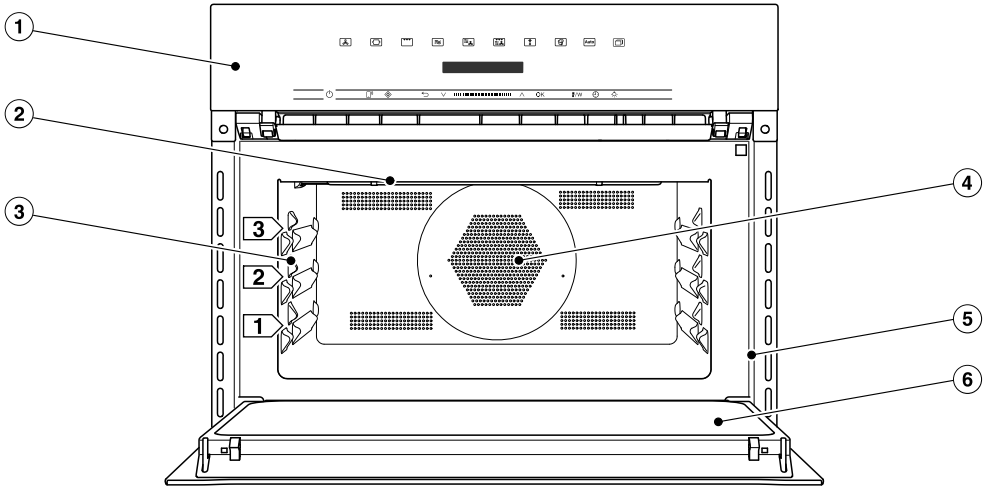





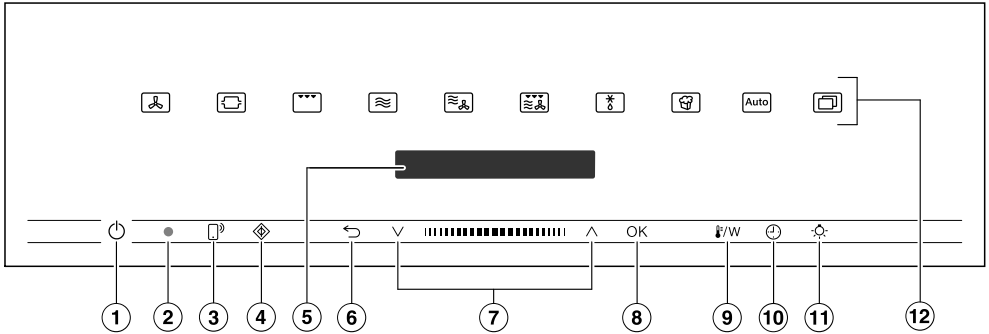

## Oven



- ① Control elements
- ② Grill element
- ③ 3 shelf levels for the glass tray and rack
- ④ Air inlet for the fan with ring heating element behind it
- ⑤ Front frame with data plate
- ⑥ Door

# Controls



- ① **Recessed  On/Off sensor control**  
For switching the oven on and off
- ② **Optical interface**  
(For Miele Service only)
- ③ ** sensor control**  
For controlling the oven via your mobile device
- ④ ** sensor control**  
For starting the Quick MW function
- ⑤ **Display**  
For displaying the time of day and information on operation
- ⑥ ** sensor control**  
For going back a step and for changing menu options during a cooking programme
- ⑦ **Navigation area with  and  arrow buttons**  
For scrolling through lists and for changing values
- ⑧ **OK sensor control**  
For selecting functions and saving settings
- ⑨ ** /W sensor control**  
For changing the temperature or the power level
- ⑩ ** sensor control**  
For setting a minute minder, the cooking duration or the start or end time for the cooking programme
- ⑪ ** sensor control**  
For switching the oven interior lighting on and off
- ⑫ **Sensor controls**  
For selecting functions, automatic programmes and settings

## On/Off sensor control

The  On/Off sensor control is recessed and reacts to touch.

Use this sensor control to switch the oven on and off.

## Display

The display is used for showing the time of day or information about functions, temperatures, cooking durations, automatic programmes and settings.

After switching the oven on with the  On/Off sensor control, Select function will appear in the main menu.

## Sensor controls

The sensor controls react to touch. Every touch of a sensor is confirmed with an audible keypad tone. You can turn this keypad tone off using Further  | Settings | Volume | Keypad tone.





If you want the sensor controls to respond even when the oven is switched off, select the Display | QuickTouch | On setting.



## Sensor controls above the display

For information on the functions and operating modes, see “Main and sub-menus”, “Settings”, “Automatic programmes” and “Further applications”.

# Controls





## Sensor controls under the display

Sensor control	Function
	<p>If you want to control the oven from your mobile device, you must have the Miele@home system, switch on the Remote control setting and touch this sensor control. The sensor control then lights up and the MobileStart function is available.</p> <p>As long as this sensor control is lit, you can control the oven via your mobile device (see “Settings – Miele@home”).</p>
	<p>Use this sensor control to start the Quick MW function. The cooking programme runs with the maximum power level (1000 W) and a cooking duration of 1 minute (see “Quick MW”). Touching the sensor control repeatedly increases the cooking duration in set stages.</p> <p>This function can only be used when no other cooking programmes are in use.</p>
	<p>Depending on which menu you are in, this sensor control will take you back a level or back to the main menu.</p> <p>If a cooking programme is in progress at the same time, use this sensor control to cancel the programme.</p>
	<p>In the navigation area, use the arrow buttons or the area between them to scroll up or down in the selection lists. The display shows the menu option that you want to select.</p> <p>You can change the values and settings using the arrow buttons or the area between them.</p>
OK	<p>As soon as you reach a confirmable value, message or setting, the OK sensor control will light up orange.</p> <p>By selecting this sensor control you can access functions such as the minute minder, save changes to values or settings or confirm instructions.</p> <p>You can start, interrupt and continue a cooking programme with microwave power with the OK sensor control.</p>

Sensor control	Function
	<p>During the heating-up phase and while cooking, you can use this sensor control to change the temperature or the microwave power level.</p> <p>You can change the temperature for functions which do not use microwave power.</p> <p>You can change the microwave power level for functions which use microwave power.</p>
	<p>If no cooking programme is in progress, you can use this sensor control to set a minute minder (e.g. when boiling eggs) at any point.</p> <p>If a cooking programme is in progress at the same time, you can set a minute minder, the cooking duration and a start or end time for the programme.</p>
	<p>Select this sensor control to switch the oven interior lighting on and off.</p> <p>Depending on the setting selected, the oven interior lighting switches off after 15 seconds or remains constantly switched on or off.</p>

## Symbols

The following symbols may appear in the display:

Symbol	Meaning
	This symbol indicates that there is additional information and advice about using the appliance. Press the <i>OK</i> sensor control to confirm the information.
	Minute minder
	A tick indicates the option which is currently selected.
	Some settings, e.g. display brightness and buzzer volume are selected using a bar chart.
	The system lock prevents the oven being switched on by mistake (see “Settings – Safety”).

## Using the appliance

---

Use the  $\wedge$  and  $\vee$  arrow buttons or the **|||||** area between them in the navigation area to use the oven.

As soon as you reach a confirmable value, message or setting, the OK sensor control will light up orange.

### Selecting a menu option

- Touch the  $\wedge$  or  $\vee$  arrow buttons or swipe to the right or left in the **|||||** area until you reach the desired menu option.

**Tip:** If you press and hold an arrow button, the list continues scrolling automatically until you release the arrow button.

- Confirm your selection with *OK*.

### Changing a setting in a list

A  $\checkmark$  tick will appear beside the current setting.

- Touch the  $\wedge$  or  $\vee$  arrow buttons or swipe to the right or left in the **|||||** area until you reach the desired value or setting.
- Confirm with *OK*.

The setting is now saved. This will take you back to the previous menu.

### Changing the setting with a segment bar

Some settings are represented by a bar **■■■■■□□□** with seven segments. If all of the segments are illuminated, the maximum value is selected.

If none of the segments are illuminated, or only one of them is, the minimum value is selected or the setting is switched off altogether (e.g. volume).

- Touch the  $\wedge$  or  $\vee$  arrow buttons or swipe to the right or left in the **|||||** area until you reach the desired setting.
- Confirm your selection with *OK*.

The setting is now saved. This will take you back to the previous menu.

## Selecting a function or operating mode

The sensor controls for the functions and operating modes (e.g. Further ) are located above the display (see “Controls” and “Settings”).

- Touch the sensor control for the desired function.

The sensor control on the fascia panel lights up orange.

- For functions and operating modes: set values such as the temperature.
- Under Further : scroll through the lists until you reach the desired menu option.
- Confirm with *OK*.

## Changing the function

You can change to another function during a cooking programme.

The sensor control for the previously selected function lights up orange.

- Touch the sensor control of the new function or operating mode.

The new function appears in the display with its corresponding recommended values.

The sensor control for the new function lights up orange.

Under Further , scroll through the lists until you reach the desired menu option.

## Entering numbers

Numbers that can be changed are highlighted.

- Touch the  $\wedge$  or  $\vee$  arrow buttons or swipe to the right or left in the  area until the desired number is highlighted.

**Tip:** If you press and hold an arrow button, the numbers continue scrolling automatically until you release the arrow button.

- Confirm with *OK*.

The changed number is now saved. This will take you back to the previous menu.

## Activating MobileStart

- Select the  sensor control to activate MobileStart.

The  sensor control lights up. You can operate your oven remotely with the Miele app.

Directly operating the oven takes priority over operating it via the remote control function on the app.

You can use MobileStart as long as the  sensor control is lit up.

# Features

---

A list of the models described in these operating and installation instructions can be found on the back page of this booklet.

## Data plate

The data plate is located on the front frame, visible when the door is open.

The data plate states the model number, the serial number as well as connection data (voltage, frequency and maximum rated load).

Please have this information to hand, should you need to contact Miele regarding any questions or problems.

## Scope of delivery

- The operating and installation instructions for using the oven and microwave functions
- A cookbook with recipes for the automatic programmes and other functions
- Screws for securing your oven in the housing unit
- Various accessories

## Accessories supplied and available to order

This oven is supplied with a glass tray and a rack.

All the accessories listed as well as the cleaning and care products are designed for Miele ovens.

These are available to order via the Miele Webshop, the Miele Customer Service Department or from your Miele dealer.

When ordering, please quote the model identifier of your oven and the reference number of the accessories required.

## Glass tray

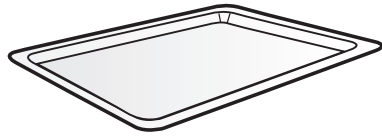

The glass tray is suitable for use with all cooking functions.

The glass tray can be damaged by large temperature fluctuations. Do not place the hot glass tray on a cold surface, such as a tiled or granite worktop. Use a suitable mat or pot rest.

- **Always** use the glass tray with the Microwave  operating mode, even if you use it as a container for smaller dishes.
- The maximum load for the glass tray is 8 kg.



## Rack with non-tip safety notches

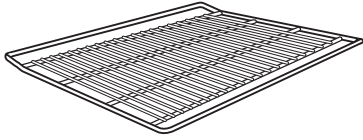

The rack is **not** suitable for use with the Microwave  function. You can use the rack for all other functions which use or do not use microwave power.

 Risk of injury caused by hot surfaces.

The rack gets hot during cooking programmes.

Use oven gloves when placing food in the oven or removing it and when working in the hot oven compartment.

The oven and rack can be damaged by the possible creation of sparks.

Do not use the rack for cooking programmes with the Microwave  function.

Do not place the rack on the oven floor but use it on one of the shelf levels.

## Using the rack

The rack has non-tip safety notches which prevent it being pulled right out when it only needs to be pulled out partially.

If you insert the rack the wrong way round, the non-tip safety mechanism is not guaranteed.

When pushing the rack back in, always ensure that the safety notches are at the **back** of the oven.

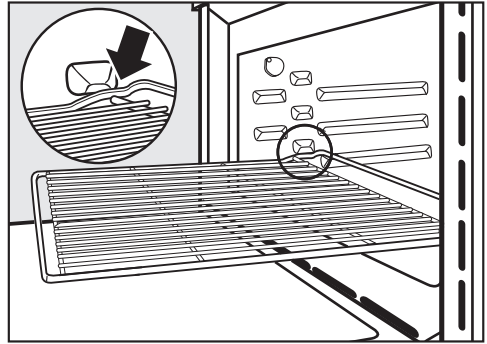

- To remove the rack, lift it upwards slightly at the front when the safety notches connect with the sides of the oven.

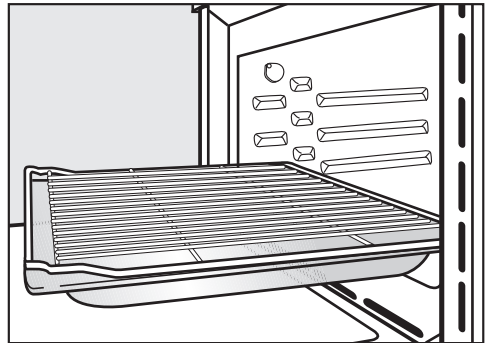





- We recommend using the rack together with the glass tray when cooking items on the rack which might drip. Only in this case should the safety notches be at the front.
- The maximum load for the rack is 8 kg.

# Features

## Round baking trays

The round baking trays can suffer damage when subjected to microwaves.

Do not use the round baking trays with the Microwave , MW + Auto roast , MW + Fan plus , MW + Grill  or MW + Fan grill  functions.



The **solid round baking tray HBF 27-1** is suitable for cooking pizzas, flat cakes made with yeast or creamed mixtures, sweet and savoury tarts, baked desserts, flat bread, and can also be used for frozen cakes and pizzas.

The **perforated round baking and AirFry tin HBFP 27-1** can be used for the same purposes as the **Gourmet baking and AirFry tray, perforated HBBL 71**.

The enamelled surface of both items of bakeware has been treated with PerfectClean.

- Insert the rack and place the round baking tray on the rack.

## HUB Gourmet oven dishes HBD Gourmet oven dish lids

Gourmet oven dishes and their lids can suffer damage when subjected to microwaves. Metal reflects the microwaves which can create sparks and the microwaves are not absorbed by the metal.

Only use the oven dishes and their lids for cooking programmes with functions which **do not use** microwave power.

Slide the rack onto shelf level 1 and place the Gourmet oven dish on the rack.

The surface of the Gourmet oven dishes has a non-stick coating and is suitable for induction hobs.

Gourmet oven dishes are available in different depths. The width and the height are the same.

Suitable lids are available separately. Please quote the model number when ordering.

**Depth: 22 cm**

HUB 62-22

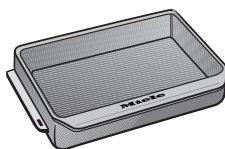

HBD 60-22

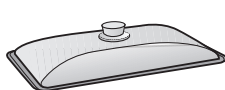

**Depth: 35 cm\***

HUB 62-35

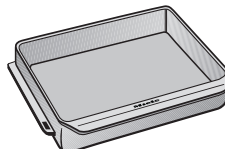

HBD 60-35



\* The oven dish cannot be used in conjunction with its lid in ovens with 3 shelf levels because the total height of these two items exceeds the height of the oven compartment.

## Accessories for cleaning and care

- Miele all-purpose microfibre cloth
- Miele oven cleaner

## Safety features

- **System lock**   
(see “Settings – Safety”)
- **Sensor lock**  
(see “Settings – Safety”)
- **Cooling fan**  
(see “Settings – Cooling fan run-on”)
- **Safety switch-off**  
A function which does not use microwave power can be started without selecting a cooking duration. To prevent continuous use and avoid the risk of fire, the oven will switch itself off automatically after a certain time depending on the function and temperature selected.

## PerfectClean treated surfaces

PerfectClean surfaces have very good non-stick properties and are exceptionally easy to clean.

Food can be easily removed from these surfaces. Soiling from baking and roasting can be easily removed from these surfaces.

Food can be sliced or cut up on PerfectClean surfaces.

However, do not use ceramic knives as these will scratch the PerfectClean surface.

Surfaces treated with PerfectClean enamel can be cleaned as you would clean glass.

Read the instructions in “Cleaning and care” so that the benefits of the non-stick properties and easy cleaning are retained.

PerfectClean treated surfaces:

- Oven compartment
- Rack
- Round baking and AirFry tin, perforated
- Round baking tray

# Before using for the first time

---

## Miele@home

Your oven is equipped with an integrated WiFi module.

In order to use it, you will need:

- A WiFi network
- The Miele app
- A Miele user account The user account can be created via the Miele app.

The Miele app will guide you as you connect your oven to your home WiFi network.

Once your oven is connected to your WiFi network, you can use the app, for example, to carry the following activities:

- Call up information on the operating status of your oven
- Retrieve information on oven cooking programmes that are in progress
- End cooking programmes that are in progress

Connecting your oven to your WiFi network will increase energy consumption, even when the oven is switched off.

Make sure that the signal of your WiFi network is sufficiently strong in the place where your oven is installed.

## Availability of the WiFi connection

The WiFi connection shares a frequency range with other appliances (including microwave ovens and remote control toys). This can give rise to sporadic or even complete connection failures. Therefore, the availability of featured functions cannot be guaranteed.

## Miele@home availability

The ability to use the Miele app depends on the availability of the Miele@home service in your country.

The Miele@home service is not available in every country.

For information about availability, please visit [www.miele.com](http://www.miele.com).

## Miele App

The Miele App is available to download free of charge from the Apple App Store® or from the Google Play Store™.



# Before using for the first time

## Basic settings

The following settings must be made before starting up for the first time. You can change these settings again at a later time (see “Settings”).

 Risk of injury caused by hot surfaces.

The oven gets hot during operation. For safety reasons, the oven may only be used when it has been fully installed.

The oven will switch on automatically when it is connected to the electricity supply.

## Setting the language

- Select the desired language.

If you have selected the wrong language by mistake, proceed as described in “Settings –  Language”.

## Setting the location

- Select the required location.

## Setting up Miele@home

Set up “Miele@home” will appear in the display.

- To set up Miele@home now, confirm by touching *OK*.
- To set it up at a later date, select *Skip* and confirm with *OK*. See “Settings – Miele@home” for information on setting up at a later date.
- To set up Miele@home now, select the desired connection method.

You will then be guided by the display and the Miele app.

## Setting the time

- Set the time of day in hours and minutes.
- Confirm with *OK*.

## Completing the commissioning process

- Follow any further instructions in the display.

The oven is now ready for use.

## Before using for the first time

### Heating up the oven for the first time

When the oven is heated up for the first time it may give off a slight smell. This can be eliminated by heating the empty oven for at least an hour.

It is important to ensure that the kitchen is well ventilated during this operation.  
Prevent the odour from escaping into other rooms.

- Remove any protective wrapping and stickers from the oven and accessories.
- Take all accessories out of the oven compartment and clean them (see “Cleaning and care”).
- Before heating the oven up, wipe the interior with a damp cloth to remove any dust or bits of packaging that may have accumulated in the oven compartment during storage and unpacking.
- Turn the oven on using the On/Off  sensor control.

Select function **appears**.

- Select Fan plus .

The recommended temperature will appear (160 °C).

The oven heating, lighting and cooling fan will switch on.

- Set the maximum possible temperature (250 °C).
- Confirm with *OK*.

Heat the oven for at least an hour.

- After at least an hour, switch the oven off with the On/Off  sensor control.

### Cleaning the oven compartment after heating it up for the first time

 Risk of injury caused by hot surfaces.





The oven gets hot during operation. You could burn yourself on the heating elements and oven compartment.

Allow the heating elements and oven compartment to cool before manual cleaning.

- Clean the oven compartment with a clean sponge and a solution of hot water and washing-up liquid or a damp microfibre cloth.
- Dry all surfaces with a soft cloth.

Leave the oven door open until the oven compartment is completely dry.

## Settings overview

Menu option	Available settings
Language 	...   deutsch   english   ... Location
Time	Display On*   Off   Night dimming Clock format 12 h   24 h* Set
Lighting	On "On" for 15 seconds* Off
Display	Brightness  QuickTouch On   Off*
Volume	Buzzer tones Melodies*  Solo tone  Keypad tone  Welcome melody On*   Off
Units	Weight g*   lb/oz   lb Temperature °C*   °F
Quick MW	Power level Duration
Popcorn	Duration
Booster	On* Off
Recommended temps.	
Recommend. power levels	

\* Factory default setting

# Settings



Menu option	Available settings
Cooling fan run-on	Temperature controlled* Time controlled
Safety	Sensor lock On   Off* System lock  On   Off*
Miele@home	Activate   Deactivate Connection status Set up again Reset Set up
Remote control	On* Off
RemoteUpdate	On* Off
Software version	
Showroom programme	Demo mode On   Off*
Factory default	Appliance settings Recommend. power levels Recommended temps.

\* Factory default setting



## Opening the “Settings” menu

In the Further  | Settings menu, you can personalise your oven by adapting the factory default settings to suit your requirements.

- Select Further .
- Select Settings .
- Select the desired setting.



You can check settings or change them.

Settings cannot be changed while a cooking process is in progress.

## Language

You can set your language and location.

After selecting and confirming your choice, the language you have selected will appear in the display.

**Tip:** If you have selected the wrong language by mistake, select the  sensor control. Follow the  symbol to get back to the Language  sub-menu.

## Time

### Display

Select how you want the time of day to show in the display when the oven is switched off:

- On  
The time is always visible in the display.  
If you also select the Display | QuickTouch | On setting, all sensor controls react to touch as normal.  
If you also select the Display | QuickTouch | Off setting, the oven has to be switched on before it can be used.
- Off  
To save energy, the display does not light up. The oven has to be switched on before it can be used.
- Night dimming  
To save energy, the time only shows in the display between 05:00 a.m. and 11:00 p.m. The display remains dark at all other times.

### Clock format

The time of day can be displayed in the 24 or 12-hour format (24 h or 12 h).

### Set

Set the hours and the minutes.



If there is a power cut, the current time of day will reappear once power has been restored. The time of day is saved for approx. 150 hours.

If the oven has been connected to a WiFi network and signed into the Miele app, the time will be synchronised based on the location setting in the Miele app.

# Settings

---



## Lighting

- On  
The oven interior lighting is switched on during the entire cooking period.
- "On" for 15 seconds  
The oven interior lighting switches off 15 seconds after a cooking programme has begun. Press the  sensor control to switch the oven interior lighting on again for 15 seconds.
- Off  
The oven interior lighting is switched off. Press the  sensor control to switch on the oven interior lighting for 15 seconds.

## Display

### Brightness

The display brightness is represented by a bar with seven segments.

-   
Maximum brightness
-   
Minimum brightness

### QuickTouch

Select how the sensor controls should respond when the oven is switched off:

- On  
If you have also selected the Time | Display | On or Night dimming setting, the sensor controls will also respond when the oven is switched off.
- Off  
Independently of the Time | Display setting, the sensor controls only respond when the oven is switched on, as well as for a certain amount of time after switching it off.

## Volume



### Buzzer tones

If buzzers are switched on, a buzzer will sound when the set temperature is reached and at the end of a set time.

### Melodies

At the end of a process, a melody will sound several times in intervals.

The volume of the melody is represented by a bar with seven segments.

-   
Maximum volume
-   
Melody is switched off

### Solo tone

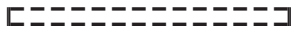

At the end of a process, a continuous tone will sound for a period of time.

The pitch of this continuous tone is represented by a segment bar.

-   
Maximum pitch
-   
Minimum pitch

### Keypad tone

The volume of the tone that sounds each time you touch a sensor control is represented by a bar with seven segments.

-   
Maximum volume
-   
Tone is switched off

### Welcome melody

The melody that sounds when you touch the  On/Off sensor control can be switched on or off.

## Units

### Weight

For automatic programmes, you can set the weight of food in grams (g), pounds/ounces (lb/oz) or pounds (lb).

### Temperature

You can set the temperature in degrees Celsius (°C) or degrees Fahrenheit (°F).

## Quick MW

The maximum microwave power level of 1000 W and the maximum cooking duration of 1 minute are pre-set for starting the microwave oven immediately.

- Power level  
The following microwave power levels can be selected: 80 W, 150 W, 300 W, 450 W, 600 W, 850 W or 1000 W.
- Duration  
The maximum cooking duration that can be set depends on the microwave power level selected:  
80–300 W: maximum 10 minutes  
450–1000 W: maximum 5 minutes

## Popcorn

A microwave power level of 850 W and a cooking duration of 2:50 minutes is pre-set so that you can start cooking a bag of microwave popcorn immediately. These settings match the manufacturer's instructions on most bags of microwave popcorn.

The maximum cooking duration that can be set is 4 minutes.

The microwave power level is set and cannot be modified.

## Booster

The **Booster** function is used to quickly pre-heat the oven compartment.

- On  
The **Booster** function is automatically switched on during the heating-up phase of a cooking programme. The grill element, ring heating element and hot air fan pre-heat the oven compartment to the set temperature at the same time.
- Off  
The **Booster** function is switched off during the heating-up phase of a cooking programme. Only the heating elements associated with the function are pre-heating the oven compartment.

## Recommended temps.

If you often cook with different temperatures, it makes sense to change the recommended temperatures.

After selecting this menu option, the list of operating modes will appear in the display together with their recommended temperatures.

- Select the relevant operating mode.
- Change the recommended temperatures.
- Confirm with *OK*.

Changing the recommended temperatures also affects the corresponding function which uses microwave power.

# Settings





---

## Recommend. power levels

If you often cook with different power levels, it makes sense to change the recommended microwave power levels.

You can change the recommended power levels for the Microwave  function and for the functions which use microwave power.

After selecting this menu option, a list of functions will appear in the display together with their recommended power levels.

- Microwave :  
80 W, 150 W, 300 W, 450 W, 600 W, 850 W, 1000 W
- MW + Auto roast , MW + Fan plus , MW + Grill  and MW + Fan grill :  
80 W, 150 W, 300 W

- Select the desired function.
- Change the recommended power level.
- Confirm with *OK*.

## Cooling fan run-on

The cooling fan will continue to run for a while after the oven has been switched off to prevent any humidity building up in the oven compartment, on the fascia panel or on the oven housing unit.

- Temperature controlled  
The cooling fan switches off when the temperature in the oven drops below 70 °C.
- Time controlled  
The cooling fan switches off after a period of about 25 minutes.

Condensate can damage the oven housing unit and the worktop and lead to corrosion in the oven.

If you have set the cooling fan to *Time controlled* and leave food in the oven compartment to keep warm, moisture levels in the oven will increase, leading to condensation forming on the fascia panel and surrounding kitchen furniture, and drops of moisture collecting under the worktop.

Do not leave food in the oven compartment to keep it warm if you have selected *Time controlled*.

## Safety

### Sensor lock

The sensor lock prevents the cooking programme being switched off by mistake or settings being changed. Apart from the  On/Off sensor control, the activated sensor lock prevents the sensor controls and fields in the display from working a few seconds after a programme has been started.

- On  
The sensor lock is activated. Touch the *OK* sensor control for at least 6 seconds to deactivate the sensor lock for a short period of time.
- Off  
The sensor lock is deactivated. All sensor controls react to touch as normal.

### System lock

The system lock prevents the oven being switched on by mistake. The minute minder and the MobileStart function can still be used when the system lock is active.

The system lock will remain activated even after a power failure.

- On  
The system lock has been activated. Before you can use the oven, touch the *OK* sensor control for at least 6 seconds.
- Off  
The system lock is deactivated. You can use the oven as normal.

## Miele@home

The oven is a Miele@home-compatible appliance. Your oven is fitted ex-works with a WiFi communication module and is suitable for wireless communication.

There are a number of ways of connecting your oven to your WiFi network. We recommend connecting your oven to your WiFi network with the help of the Miele app or via WPS.

- Activate  
This setting is only visible if Miele@home is deactivated. The WiFi function is reactivated.
- Deactivate  
This setting is only visible if Miele@home is activated. Miele@home remains set up, the WiFi function is switched off.
- Connection status  
This setting is only visible if Miele@home is activated. The display shows information such as the WiFi reception quality, network name and IP address.
- Set up again  
This setting is only visible if a WiFi network has already been set up. Reset the network settings and immediately set up a new network connection.
- Reset  
This setting is only visible if a WiFi network has already been set up. The WiFi function is deactivated and the WiFi network connection will be reset to the factory default. You must set up a new WiFi network connection to

# Settings

---

be able to use Miele@home. The network settings should be reset whenever an oven is being disposed of or sold, or if a used oven is being put into operation. This is the only way to ensure that all personal data has been removed and the previous owner will no longer be able to access the oven.

- Set up  
This setting is only visible if no WiFi network connection has been set up yet. You must set up a new WiFi network connection to be able to use Miele@home.

## RemoteUpdate

The RemoteUpdate menu option is only displayed and can only be selected if the requirements for using Miele@home have been met (see “Before using for the first time – Miele@home”).

The RemoteUpdate function is used for updating the software in your oven. If an update is available for your oven, it will automatically download it. Updates will not be installed automatically. They must be initiated manually.

If you do not install an update, you can continue to use your oven as usual. However, Miele recommends installing updates.

### Activating/deactivating

The RemoteUpdate function is activated as standard. Available updates will be downloaded automatically but will only be installed if you initiate installation manually.

Deactivate RemoteUpdate if you do not want any updates to be downloaded automatically.

### Running a RemoteUpdate

Information about the content and scope of an update will be provided in the Miele app.

A message will appear in your oven display if a software update is available.

You can install the update immediately or postpone this until later. When the oven is switched on again, you will be reminded about the update.

Deactivate RemoteUpdate if you do not want to install the update.

The update may take several minutes.

Please note the following information about the RemoteUpdate function:

- You will only receive a message when an update is available.
- Once an update has been installed, it cannot be undone.
- Do not switch the oven off during the update. Otherwise, the update will be aborted and will not be installed.
- Some software updates can only be carried out by the Miele Customer Service Department.

## Remote control

If you have installed the Miele app on your mobile device, have access to the Miele@home system and have activated the remote control function (On), you can use the MobileStart function and for example retrieve information about oven cooking processes that are in progress or end a process that is in progress.

The oven requires max. 2 W when operating in networked standby.

### Activating MobileStart

- Select the  sensor control to activate MobileStart.

The  sensor control lights up. You can operate your oven remotely with the Miele app.

Directly operating the oven takes priority over operating it via the remote control function on the app.

You can use MobileStart as long as the  sensor control is lit up.

## Software version

The software version is intended for the Miele Customer Service Department. You do not need this information for domestic use.

## Showroom programme

This function enables the oven to be demonstrated in showrooms without heating up. This setting is not needed for domestic use.

### Demo mode

If you have demo mode activated, Demo mode active. The appliance will not heat up will appear when you switch the oven on.

- On  
Touch the OK sensor control for at least 4 seconds to activate demo mode.
- Off  
Touch the OK sensor control for at least 4 seconds to deactivate demo mode. You can use the oven as normal.

## Factory default

- Appliance settings  
Any settings that have been altered will be reset to the factory default settings.
- Recommend. power levels  
Microwave power levels which have been changed will be reset to the factory default settings.
- Recommended temps.  
Any recommended temperatures that have been changed will be reset to the factory default settings.

# Min. minder

---

## Using the Min. minder function

The ⏰ minute minder can be used to time other activities in the kitchen, e.g. boiling eggs.

The minute minder can also be used at the same time as a cooking programme for which the cooking duration start and finish times have been set (e.g. as a reminder to stir the food or add seasoning, etc.).

- The maximum minute minder time that can be set is 59 minutes and 59 seconds.

## Setting the minute minder

If you have selected the Display | QuickTouch | Off setting, you will need to switch the oven on before setting the minute minder. The minute minder can then be seen counting down in the display when the oven is switched off.

Example: you want to boil some eggs and set a minute minder duration of 6 minutes and 20 seconds.

- Select the ⏰ sensor control.
- Select Min. minder if a cooking programme is in progress at the same time.

The prompt Set 00:00 min appears.

- Using the navigation area, set 06:20.
- Confirm with OK.

The minute minder duration is now saved.

When the oven is switched off, the minute minder time counts down in the display and ⏰ appears instead of the time of day.

If you are cooking at the same time **without** a set cooking duration, ⏰ and the minute minder time appear as soon as the selected temperature is reached.

If you are cooking at the same time **with** a set cooking duration, the minute minder counts down in the background as the cooking duration appears first in the display.

If you are in a menu, the minute minder counts down in the background.

At the end of the minute minder time, ⏰ will flash, the time will start counting up and a buzzer will sound.

- Select the ⏰ sensor control.
- If required, confirm with OK.

The buzzer will stop and the symbols in the display will go out.

## Changing the minute minder duration

- Select the ⏰ sensor control.
- Select Min. minder if a cooking programme is in progress at the same time.
- Select Change.
- Confirm with OK.

The minute minder duration selected appears.

- Change the duration set for the minute minder.
- Confirm with OK.

The altered minute minder duration is now saved.











## Deleting the minute minder duration

- Select the ⏰ sensor control.
- Select Min. minder if a cooking programme is in progress at the same time.
- Select Delete.
- Confirm with OK.

The minute minder duration is now deleted.



## Main and sub-menus

Menu	Recommended value	Range
Oven functions		
Fan plus 	160 °C	30–250 °C
Auto roast 	160 °C	100–230 °C
Grill 	3	1–3
Microwave 	1000 W	80–1000 W
MW + Fan plus 	300 W 160 °C	80–300 W 30–220 °C
MW + Fan grill 	300 W 200 °C	80–300 W 100–200 °C
Defrost 	25 °C	25–50 °C
Popcorn 	850 W	–
Automatic programmes 		
Further 		
Eco Fan heat	190 °C	100–230 °C
Fan grill	200 °C	100–220 °C
MW + Grill	300 W 3	80–300 W 1–3
MW + Auto roast	300 W 160 °C	80–300 W 100–200 °C
Settings 		

# Microwave operation

## How it works

The oven contains a magnetron that converts electrical energy into electromagnetic waves (microwaves). These microwaves are distributed evenly throughout the oven compartment, and are reflected off the metal appliance walls.

The microwaves penetrate inside the food from all sides. Food consists of many molecules. When subjected to microwave energy, these molecules (particularly the water molecules) start to oscillate. This heats the food from the outside to the inside. The more water a food contains, the faster it is reheated or cooked.

## Advantages of the microwave oven

- Food can generally be cooked without having to add any/very much extra liquid or fat.
- The durations for defrosting, reheating or cooking are shorter than with a hob or oven.
- Vitamins, minerals, natural colour, and taste of the food are generally retained.

If the oven is used without food or the food is loaded incorrectly when using the Microwave  operating mode or operating modes that use microwave power, the oven can become damaged.

**Always** use the glass tray with the Microwave  operating mode, even if you use it as a container for smaller dishes.

## Selecting crockery

In order for microwaves to reach the food, they must be able to penetrate the crockery being used. Microwaves can pass through porcelain, glass, cardboard and plastics, but not metal. Therefore, do not use metal containers or crockery that contains metal. Metal reflects the microwaves which can create sparks and the microwaves are not absorbed by the metal.

 Risk of injury from increased pressure in closed containers or bottles

Pressure can build up during reheating in sealed containers or bottles, causing them to explode. Never cook or reheat solid or liquid food in sealed containers or bottles. Open containers beforehand. In the case of baby bottles, the screw top and teat must be removed.

 Fire hazard due to using unsuitable crockery for operating modes which use microwave power. Crockery which is not suitable for use in microwave ovens can be badly damaged and cause damage to the oven.

Only use microwave-safe crockery for operating modes which use microwave power.

The material and shape of the crockery used affect the reheating and cooking durations.

Heat distribution is more even in round and oval-shaped shallow containers. Food is reheated more evenly in these containers than in square containers.

## Suitable crockery

 Fire hazard due to inflammable materials.

Disposable containers made out of plastic, paper or other inflammable materials can ignite, causing damage to the oven.

Do not leave the oven unattended when reheating or cooking food in disposable containers made of plastic, paper or other inflammable materials.

You can use the following crockery and materials:

- Heat-resistant glass and ceramic glass  
Exception: crystal glass as it contains lead and may crack.
- Porcelain
  - Without metallic decoration  
Metallic decoration (e.g. gold rims or cobalt blue) can cause sparking.
  - Without hollow knobs and handles  
Moisture can gather in the hollow knobs and handles. When the moisture evaporates, pressure can build up and the item can explode.
- Unpainted stoneware and stoneware with underglaze paints

 Risk of injury caused by hot crockery.

Stoneware can get hot.





Wear oven gloves when using stoneware.

- Plastic containers and plastic disposable containers with the Microwave  operating mode

**Tip:** To protect the environment, avoid the use of disposable containers.

Plastics must be heat-resistant to a minimum of 110 °C. Otherwise the plastic may melt and fuse with the food.

Only use plastic containers with the Microwave  function.









Do not use plastic containers with the MW + Auto roast , MW + Fan plus , MW + Grill  or MW + Fan grill  functions.

- Microwave-safe plastic containers  
Special plastic containers designed for use in microwave ovens are available from retail outlets.
- Styrofoam containers  
For briefly heating food
- Plastic boiling bags  
For cooking and reheating. They should be pierced beforehand. The holes allow the steam to escape. This prevents a build-up of pressure from forming and the bag from bursting. There are also special bags available for steam cooking which do not need to be pierced. Please follow instructions given on the packet.
- Roasting bags and tubes  
Please follow the manufacturer's instructions.

 Fire hazard due to metal parts.  
Metal parts such as metal clips or plastic and paper ties that have wire running through them can heat inflammable materials until they burn.  
Do not use metal clips or plastic and paper ties containing wire.

## Microwave operation

**Tip:** Metal tins are less suitable for operating modes which use microwave power because the metal reflects the microwaves. The microwaves only reach the cake from above, which extends the baking duration. If you use metal tins, place the tin on the glass tray so that it cannot touch the oven walls. If sparks form, do not reuse the tin for operating modes which use microwave power.

- The **supplied** rack is only suitable for cooking processes with the MW + Auto roast , MW + Fan plus , MW + Grill  and MW + Fan grill  operating modes as well as for operating modes which do not use microwave power (placed on one level).
- Metal baking tins for baking with the MW + Auto roast , MW + Fan plus , MW + Grill  and MW + Fan grill  operating modes as well as for operating modes which do not use microwave power
- Aluminium foil trays without lids for defrosting and reheating ready meals  
The food is only heated from the top. If you remove the food from the aluminium foil container and transfer it to crockery suitable for use in a microwave oven, the heat distribution will generally be more even.

Using aluminium foil trays and aluminium foil can cause crackling and sparks.

Therefore, place aluminum foil trays on the glass tray and not on the rack. Aluminium foil and aluminium foil trays must not touch the oven compartment walls and must remain at least 2 cm from the walls at all times.

- Metal meat skewers or clamps  
The size of the cut of meat must be much larger than the metal skewers and clamps.

### Unsuitable crockery

Crockery and lids with hollow handles or knobs can collect moisture in the hollow spaces. When the moisture evaporates, pressure can build up and the item can explode. If the hollow recess is sufficiently ventilated, the item can be used.

Do not use crockery with hollow knobs or handles for cooking.

Do **not** use the following crockery and material:

- Metal racks (including the supplied rack) are **not** suitable for use with the Microwave  operating mode.
- Metal containers
- Aluminium foil  
Exception: for even defrosting, reheating or cooking of unevenly shaped cuts of meat, e.g. poultry, small pieces of aluminium foil may be used to cover thin parts for the last few minutes of the programme.
- Metal clips, plastic or paper ties containing wire
- Plastic containers where the aluminium lid has not been completely removed
- Crystal glass
- Cutlery and crockery with metallic decoration (e.g. gold rims, cobalt blue)
- Crockery with hollow handles
- Plasticware made of melamine  
Melamine absorbs microwave energy and gets hot.  
When purchasing plasticware, make sure that it is suitable for use in a microwave oven.
- Wooden dishes  
Water contained in wood evaporates during the cooking process. This causes the wood to dry and crack.

# Microwave operation

---

## Testing dishes

Unsuitable crockery can cause sparks or crackling noises. If you are not sure whether glass, porcelain or stoneware crockery is suitable, test the dishes.

This test cannot be used to check whether items with hollow knobs or handles are suitable for use.

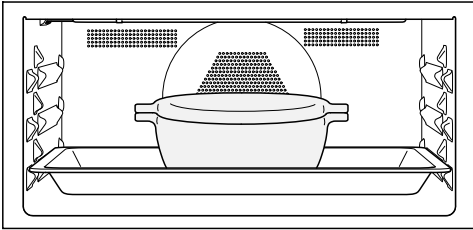

- Place the empty crockery in the middle of the glass tray and slide the tray into shelf level 1.

- Close the door.
- Select the Microwave  function.
- Set the highest microwave power level (1000 W) and a cooking duration of 30 seconds.
- Start the programme.
- Observe the crockery during the entire duration.
- Immediately open the door if there are sparks or crackling noises.

If there are sparks or if you can hear crackling noises, the tested crockery is not suitable for microwave use.

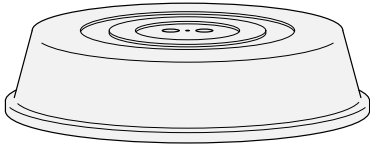

### Cover



**Tip:** Covers are available from retail outlets.

- A cover prevents too much steam escaping, especially when reheating foods over a longer period of time.
  - It speeds up the cooking process of the food.
  - It prevents food from drying out.
  - It helps keep the oven compartment clean.
- Use a glass or plastic cover suitable for microwave use for cooking processes with the Microwave  operating mode.





Alternatively, use a cling film suitable for use in a microwave oven. Heat can cause normal cling film to distort and fuse with the food.

The cover can withstand temperatures of up to 110 °C. At higher temperatures (e.g. in the Grill  or Fan plus  operating modes), the plastic may distort and fuse with the food.

Only use a cover for the Microwave  operating mode.

The cover should not form a seal with the container. If the container has a narrow diameter, the steam may not be able to escape. The cover could get too hot and start to melt.

Use containers with a sufficiently large diameter.

- Do **not** use a cover for reheating the following types of food:
- Food coated in breadcrumbs
  - Food which requires a crisp finish, e.g. toast
  - Food which must be heated with the MW + Auto roast , MW + Fan plus , MW + Grill  or MW + Fan grill  operating modes

# Operation

If you place food directly on the floor of the oven when using the Microwave  function, the oven can become damaged.

When using the Microwave  function, place the glass tray on level 1 and **always** place containers such as cups and baking tins on the glass tray.



- Switch the oven on.

The main menu will appear.

- Place the food in the oven compartment.
- Select the operating mode you want to use.

The operating mode will appear first. Depending on the operating mode, the recommended temperature, recommended power level and the cooking duration will appear one after the other in the display.

- Change the recommended values for the cooking process and set the cooking duration if required.

You can subsequently change the temperature via the navigation area, the microwave power level via the  W sensor control and the cooking duration via the  sensor control.

- Confirm each entry with *OK*.  
Confirming the temperature starts the cooking process for operating modes which **do not use** microwave power.

For operating modes **which do use** microwave power, the set microwave power level and the set cooking duration appear in the display.

- Use the *OK* sensor control to start the cooking process for operating modes **which use** microwave power.

The cooking process starts.

If you have set a temperature, you will see the temperature increasing. A buzzer will sound when the set temperature is reached for the first time.

The oven stops generating microwave power when you interrupt the cooking process or open the door. You can continue the cooking process with the *OK* sensor control.

- After cooking, select the sensor control for the selected operating mode to end the cooking process.
- Take the food out of the oven compartment.
- Switch the oven off.

## Changing values and settings for a cooking programme



Depending on the function, as soon as a cooking programme is in progress, you can change the values or settings for this programme.

Depending on the function, you can change the following settings:

- Temperature
- Power level
- Duration
- Finish at
- Start at



## Changing the temperature

Select Further  | Settings  | Recommended temps., to permanently reset the recommended temperatures to suit your cooking preferences.

- Select the  $\wedge$  or  $\vee$  arrow buttons or swipe to the right or left in the  area.

The desired temperature appears in the display.

- Change the desired temperature via the navigation area.



The temperature changes in 5 °C steps.

- Confirm with *OK*.

The cooking programme will restart with the new desired temperature.

## Changing the microwave power level

You can change the microwave power level for the Microwave  function and for functions which use microwave power.

Select Further  | Settings  | Recommend. power levels, to permanently set the recommended power level to suit your personal cooking preferences.

- Select the /W sensor control.

The set microwave power level appears in the display.

- Change the microwave power level via the navigation area.

You can set the following microwave power levels: 80 W, 150 W, 300 W, 450 W, 600 W, 850 W, 1000 W.

- Confirm with *OK*.

The programme will restart with the new microwave power level.

## Setting cooking durations



Cooking results can be impaired if there is a long delay between the food being placed in the oven and the start of cooking. Fresh food can change colour and even deteriorate. When baking, the cake mixture or dough can dry out, and the raising agents can lose their effectiveness. Select as short as possible a time until the cooking programme starts.

You have placed the food in the oven compartment, selected an operating mode and the required settings such as the temperature.

By entering Duration, Finish at or Start at via the  sensor control, you can automatically switch the cooking process off or on and off.

- Duration  
Enter the required cooking duration for the food. The heating will switch off automatically once this duration has elapsed. The maximum cooking duration that can be set depends on the operating mode that you have selected.
- Finish at  
Specify when you want the cooking process to end. The oven heating will switch off automatically at the time you have set.
- Start at  
This function will only appear in the menu if you have set a Duration or Finish at time. With Start at, you have to specify when you want the cooking process to start. The oven heating will switch on automatically at the time you have set.

# Operation

- Select the  sensor control.
- Set the desired times.
- Confirm with *OK*.
- Touch the  sensor control to return to the menu for the selected operating mode.

## Changing the set cooking durations

- Select the  sensor control.
- Select the desired time.
- Confirm with *OK*.
- Select *Change*.

This menu option does not appear if you want to change the cooking duration for functions **which use** microwave power, as these functions always require a set cooking duration.

The time will be highlighted.



- Change the set time.
- Confirm with *OK*.
- Touch the  sensor control to return to the menu of the selected function.
- Use the *OK* sensor control to continue the cooking programme for functions **which use** microwave power.

These settings will be deleted in the event of a power failure.

**Tip:** You can also change the cooking duration for the *Microwave*  function via the navigation area.

## Deleting the set cooking durations

For a function **which uses** microwave power, you can only delete the set times for *Finish at* and *Start at*. The cooking duration must always be set.

- Select the  sensor control.
- Select the desired time.
- Confirm with *OK*.
- Select *Delete*.
- Confirm with *OK*.
- Touch the  sensor control to return to the menu of the selected function.

If you delete *Duration* for a function which **does not use** microwave power, the set times for *Finish at* and *Start at* are also deleted.

If you delete *Finish at* or *Start at*, the cooking programme will start using the cooking duration set.

## Interrupting a cooking programme in the Microwave function

You can interrupt cooking when using the *Microwave*  function and pause the cooking duration.

During cooking, the *OK* sensor control lights up.

- Select the *OK* sensor control.

Cooking is interrupted and the cooking duration is paused.

The *OK* sensor control lights up.

- Select the *OK* sensor control.

The cooking programme restarts and the cooking duration continues to count down.

## Cancelling a cooking programme

- Touch the sensor control for the selected function or the  sensor control.
- When **Cancel process** appears in the display, confirm with **OK**.

The oven compartment heating and lighting will then switch off. Any cooking durations set will be deleted.

The main menu will appear.

## Pre-heating the oven compartment



The **Booster** function is used to quickly pre-heat the oven compartment in some functions.



It is only necessary to pre-heat the oven compartment in a few instances.

- Place most dishes in the cold oven compartment to make use of the heat produced during the heating-up phase.
- For dark bread dough as well as beef sirloin joints and fillet, pre-heat the oven compartment when using the **Fan plus**  function.

## Booster

The **Booster** function is used to quickly pre-heat the oven compartment.

This function is switched on as the factory default setting for the following functions (Further  | Settings  | **Booster | On**):

- Fan plus 
- Auto roast 

If you set a temperature above 100 °C and the **Booster** function is switched on, a rapid heating-up phase heats the oven to the set temperature. The grill element and ring heater element come on together with the fan.

Delicate items (e.g. sponge or biscuits) will brown too quickly on the top if the **Booster** function is used.

Switch off the **Booster** function for these items.

## Switching off Booster for a cooking process

- Select the **Booster | Off** setting before selecting the desired operating mode.

The **Booster** function is switched off during the heating-up phase. Only the heater elements for the selected operating mode are used to pre-heat the oven compartment.

If you then want to restart a cooking process with the **Booster** function, select the **Booster | On** setting to switch the function on again.

## Quick MW and Popcorn

These functions can only be used when no other cooking programmes are in use.

Always use the glass tray.

### Quick MW

If you select the  sensor control, the microwave oven starts with a set microwave power level and cooking duration, e.g. to reheat a drink.

The maximum microwave power level of 1000 W and a maximum cooking duration of 1 minute are pre-set.

You can change the microwave power level and the cooking duration. The maximum cooking duration that can be set depends on the microwave power level selected (see “Settings – Quick MW”).

- Select the  sensor control.  
Touching it repeatedly increases the cooking duration in set stages.

The time left will appear in the display.

You can interrupt and restart the cooking programme at any time by touching the **OK** sensor control or cancel it with the  sensor control.

At the end of the cooking programme, **Finished** appears in the display and a buzzer sounds.

- Select the  sensor control.

The main menu will appear.

### Popcorn

If you select the  sensor control, the microwave oven starts with a set microwave power level and cooking duration.

A microwave power level of 850 W and a maximum cooking duration of 2:50 minutes are pre-set. These settings match the manufacturer’s instructions on most bags of microwave popcorn.

The maximum cooking duration that can be set is 4 minutes. The microwave power level is set and cannot be modified (see “Settings – Popcorn”).

- Select the  sensor control.

The time left will appear in the display.

You can interrupt and restart the cooking programme at any time by touching the **OK** sensor control or cancel it with the  sensor control.

Disposable containers made out of paper or other inflammable materials can ignite, causing damage to the oven.

Do not leave the oven unattended during this programme and make sure you follow the instructions on the packaging.

At the end of the cooking programme, **Finished** appears in the display and a buzzer sounds.

- Select the  sensor control.

The main menu will appear.

The wide range of automatic programmes enables you to achieve excellent results with ease.

## Categories

The **Auto** automatic programmes are sorted into categories to provide a better overview. Simply select the appropriate programme for the type of food you are cooking and follow the instructions in the display.

## Using automatic programmes

- Select Automatic programmes **Auto**.

A list will appear in the display.

- Select the desired food category.

The automatic programmes available for the food category selected will then appear.

- Select the desired automatic programme.
- Follow the instructions in the display.

## Handy hints

- When using automatic programmes, the recipes provided are designed as a guide only. Other similar recipes, including those using different quantities, can be used for the automatic programme in question.
- After cooking, allow the oven compartment to cool down to room temperature again before starting an automatic programme.
- Some automatic programmes require a pre-heating phase before food is placed in the oven compartment. A prompt will appear in the display indicating when this needs to be done.
- Some automatic programmes require the addition of liquid after a certain cooking duration. You will be prompted by a message in the display when this needs to be done (e.g for adding liquid).
- The duration quoted for automatic programmes is an estimate. It may increase or decrease depending on the programme. The duration, in particular with meat, will vary depending on the initial temperature of the food.

## Further applications



This section provides information on the following applications:

- Defrost
- Drying
- Reheating
- Cooking
- Frozen food/ready meals

### Defrost

Gentle defrosting of frozen goods means that the vitamins and minerals are generally retained.

■ Use one of the following functions:

- Defrost  function  
Set the defrosting temperature.
- Microwave  function  
Set the microwave power level and the defrosting duration.

 Risk of infection from bacteria. Bacteria such as salmonella can cause life-threatening food poisoning.

It is particularly important to observe food hygiene rules when defrosting fish and meat, and in particular when defrosting poultry.

Do not use the liquid produced during defrosting.

Process the food as required as soon as it has been defrosted.

### Tips

- Place the frozen goods to be defrosted on the glass tray without their packaging.
- For defrosting poultry, use the glass tray with the rack placed on top of it. This way the frozen goods will not be lying in the defrosted liquid.

- Meat, poultry or fish does not need to be fully defrosted before cooking. Defrost until the food has started to thaw. The surface will then be sufficiently thawed to take herbs and seasoning.

### Using the Defrost function

This function was developed to gently defrost frozen goods.

- Select Defrost .
- Alter the recommended temperatures if necessary.

Air is circulated throughout the oven compartment to gently defrost the frozen goods.

### Using the Microwave function



Alternatively, you can use the Microwave  function for defrosting. Set the microwave power level and the defrosting duration.

The time required depends on the nature of the food, its initial temperature and the amount to be cooked. Take note of the standing times.

Use crockery that is microwave safe.

- Select Microwave .
- Depending on the type of food, set the microwave power level and the defrosting duration specified in the table.
- You are generally advised to select the middle duration.
- Place the food on the glass tray on shelf level 1 in the oven compartment.

### Defrosting with the Microwave function

Food to be defrosted	Quantity	 [W]	 [min]	 <sup>1</sup> [min]
Butter	250 g	80	8–10	5–10
Milk	1000 ml	450	12–16	10–15
Sponge cake (3 slices)	Approx. 300 g	150	4–6	5–10
Fruit cake (3 slices)	Approx. 300 g	150	6–8	10–15
Butter cake (3 slices)	Approx. 300 g	150	6–8	5–10
Cream cake (3 slices)	Approx. 300 g	80	4–4:30	5–10
Yeast buns, puff pastries (3 pieces)	Approx. 300 g	150	6–8	5–10

 Microwave power level,  defrosting duration,  standing time

<sup>1</sup> Allow food to stand at room temperature. This allows the heat to spread evenly throughout the food.

## Further applications





### Drying

Dehydrating or drying is a traditional method of preserving fruit, certain vegetables and herbs.

It is important that fruit and vegetables are ripe and not bruised before they are dried.

- Peel and core the food for drying, if necessary, and cut it up.
- Distribute the food for drying evenly in a single layer according to size over the wire rack or the glass tray.
- Dry on a maximum of 2 levels at the same time.  
Place the food for drying on shelf levels 1+2.  
If you are using both the wire rack and glass tray, insert the glass tray below the wire rack.
- Select Fan plus .
- Alter the recommended temperature and then set the drying time.
- Turn the food for drying on the glass tray at regular intervals.

The drying times are longer for whole or halved dried food.

Food for drying		🌡️ [°C]	🕒 [h]
Fruit		60–70	2–8
Vegetables		55–65	4–12
Mushrooms		45–50	5–10

 Operating mode, 🌡️ Temperature, 🕒 Drying time,  Fan plus

- Reduce the temperature if condensation begins to form in the oven compartment.

### Removing the dried food

 Risk of injury caused by hot surfaces.

The oven gets hot during operation. You could burn yourself on the heating elements, oven compartment or accessories.

Use oven gloves when removing dried food from the oven.

- Allow the dried fruit or vegetables to cool down after drying.

Dried fruit needs to be completely dry, but also soft and elastic. Juice should not escape when cut.

- Store dried food in sealed glass jars or tins.



### Reheating

It is essential that the section entitled “Correct use” in the “Warning and safety instructions” is observed.

 Risk of injury caused by hot food.

If food for babies and children is reheated at too high a temperature, they can burn themselves.

Only heat food for babies and children for 30–60 seconds at 450 W.

After reheating food, especially food for babies and small children, stir the food or shake the container and taste the food so that children do not get burned.

 Risk of injury from increased pressure in closed containers or bottles.

Pressure can build up during reheating in sealed containers or bottles, causing them to explode.

Never cook or reheat food or liquids in sealed containers or bottles. Open containers beforehand. In the case of baby bottles, the screw top and teat must be removed.

Risk of injury caused by hot liquids. When heating food, and in particular liquids, using the Microwave  function, the boiling point may be reached without the production of typical bubbles. The liquid does not boil evenly throughout.

This boiling delay can result in the liquid boiling over explosively. Take care when taking the container out of the oven, as the hot liquid can cause severe scalding. Under certain circumstances, the pressure can be so high that the door opens automatically.

Stir liquids well before reheating or cooking.

After reheating, wait at least 20 seconds before removing the container from the oven compartment.

In addition, a glass rod or similar item, if available, can be placed in the container during reheating.

## Further applications

### Using the Microwave function

The Microwave  function is ideal for reheating.

The time required depends on the nature of the food, its initial temperature and the amount to be cooked. For example, food taken straight from the refrigerator takes longer to reheat than food which has been kept at room temperature. Take note of the standing times.

Use crockery that is microwave safe.  
Always cover food when reheating it, except when reheating meat/fish coated in breadcrumbs.

- Place the food that is to be reheated in the glass tray with a cover.
- Place the glass tray on shelf level 1 in the oven compartment.
- Select Microwave .
- Depending on the type of food, set a microwave power level and a cooking duration.  
You can find the values for some types of food in the table.
- Turn, separate or stir the food several times. Stir the food from the outside towards the middle, as food heats more quickly from the outside.

 Danger of burning due to hot surfaces.



The oven gets hot during operation. You could burn yourself on the heater elements, oven compartment or accessories. Droplets of water may have accumulated underneath the crockery.

Use oven gloves when working in the hot oven compartment and when removing the crockery.

During the standing time, the temperature is distributed evenly in the food.

- After reheating, allow the food to stand at room temperature for a few minutes to enable the heat to spread evenly throughout the food.

### Reheating with the Microwave function

Drink/ food	Quantity	 [W]	 [min]	 <sup>1</sup> [min]
Drinks (drinking temperature 60–65 °C)	1 cup/1 glass (200 ml)	1000	00:50–1:10	–
Baby bottle (milk) <sup>2</sup>	Approx. 200 ml	450	00:50–1:00 <sup>3</sup>	1
Food for babies and children <sup>3</sup>	1 jar (200 g)	450	00:30–1:00	1
Sliced meat with sauce <sup>3</sup>	200 g	600	3:00–5:00	1
Side dishes <sup>3</sup>	250 g	600	3:00–5:00	1

 Microwave power level,  Cooking duration,  Standing time

- <sup>1</sup> Allow food to stand at room temperature. This allows the heat to spread evenly throughout the food.
- <sup>2</sup> A boiling delay can be avoided by stirring liquids before reheating them. After reheating, wait at least 20 seconds before removing the container from the oven compartment. In addition, a glass rod or similar item, if available, can be placed in the container during reheating.
- <sup>3</sup> The durations apply to food with an initial temperature of approx. 5 °C.  
For food not normally refrigerated, durations apply to food at room temperature or approx. 20 °C.  
With the exception of baby food and delicate whisked sauces, food should be reheated to a temperature of 70–75 °C.

## Further applications

---

### Cooking

It is essential that the section entitled “Correct use” in the “Warning and safety instructions” is observed.



Food with a thick skin or peel, such as tomatoes, sausage, potatoes and aubergines can burst when reheated or cooked.

Pierce or score the skin of these types of food several times to allow steam to escape.





Eggs reheated in their shells can burst, even after they have been taken out of the oven compartment.

Eggs can only be cooked in their shells in a specially designed egg-boiling device. Do not reheat hard boiled eggs using the Microwave  function.

### Tips

- Turn, separate or stir the food several times. Stir the food from the outside towards the middle, as food heats more quickly from the outside.
- Use only crockery that is suitable for use in a microwave and oven when using functions which use microwave power.
- If possible, use the automatic programmes for cooking.
- Never use a lid with the MW + Fan grill  and MW + Grill  functions, as the food will not brown.
- With the Microwave  function, select a microwave power level of 850 W to start cooking, and then continue cooking at 450 W. Observe the information in the cooking charts at the end of this book.

### Cooking with the Microwave function

<b>Soups/stews Vegetables</b>	 [g]	 850 W [min]	+	 450 W [min]	 <sup>1</sup> [min]
Stew	1500	10	+	20	1
Soup	1500	11	+	24	1
Peas	500	5	+	10	2
Peas (frozen)	450	5	+	12	2
Carrots	500	5	+	10	2
Broccoli florets	500	6	+	8	2
Broccoli (frozen)	450	5	+	11	2
Cauliflower florets	500	6	+	10	2
Kohlrabi batons	500	3	+	8	2
Asparagus	500	5	+	8	2
Leeks	500	5	+	8	2
Leeks (frozen)	450	5	+	8	2
Sliced peppers	500	5	+	10	2
Beans, green	500	4	+	12	2
Brussels sprouts	500	5	+	12	2
Brussels sprouts (frozen)	450	5	+	10	2
Mixed vegetables (frozen)	450	5	+	12	2

 Weight,  cooking duration,  standing time

<sup>1</sup> Allow food to stand at room temperature. This allows the heat to spread evenly throughout the food.

## Further applications

### Frozen food/Ready meals

#### Tips for cakes, pizza and baguettes

- Bake cakes, pizza and baguettes on baking paper on the rack.
- Use the lowest temperature recommended on the packaging.

#### Tips for french fries, croquettes and similar items

- Bake these frozen products on baking paper in the glass tray.
- Use the lowest temperature recommended on the packaging.
- Turn the food several times during baking.

#### Preparing frozen food/ready meals

Handling food carefully will help protect your health.

Cakes, pizzas and french fries should be cooked until golden, not dark brown.

- Select the function and temperature recommended on the packaging.
- Pre-heat the oven compartment.
- Place the food in the pre-heated oven compartment on the shelf level recommended on the packaging.
- Check the food at the end of the shortest cooking duration recommended on the packaging.

### Heat crockery

Use the Fan plus  operating mode for pre-heating crockery.

Only pre-heat heat-resistant crockery.

- Place the wire rack on shelf level 1 and place the crockery to be pre-heated on it. Depending on the size of the crockery, you can also place the rack on the oven floor and take the side runners out to make more room.
- Select Fan plus .
- Set the temperature to 50–80 °C.

 Risk of burns!

Use oven gloves when removing the crockery from the oven. Droplets of water may have accumulated underneath the crockery.

- Remove the heated crockery from the oven.

Handling food carefully will help protect your health.

Cakes, pizzas and french fries should be cooked until golden, not dark brown.

## Tips on baking

- Set a cooking duration. If used for baking, do not delay the start for too long. Cake mixture or dough will dry out, and the raising agents will lose their effectiveness.
- Avoid using bright, thin-walled tins as they give an uneven or poor browning result. In some cases the food does not cook properly.
- Position rectangular tins with the longer side across the width of the oven compartment for optimum heat distribution and even baking results.
- Line the glass tray with baking paper before placing french fries, croquette potatoes and similar types of food on it.

## Notes on the cooking charts

You can find the cooking charts at the end of this book.

### Selecting the temperature

- As a general rule, select the lower temperature given in the chart. Baking at temperatures higher than those recommended may reduce the cooking duration, but will lead to uneven browning of the food, and unsatisfactory cooking results.

### Selecting the cooking duration

Unless otherwise stated, the cooking durations given in the cooking charts are for an oven compartment which has not been pre-heated. With a pre-heated oven compartment, shorten times by around 10 minutes.

- As a general rule, check the food after the shortest duration. Stick a wooden skewer into the food.

If it comes out clean without any batter/dough on it, the food is done.

# Baking

## Notes on the functions

You can find an overview of all the functions with their recommended values in “Main and sub-menus”.

### Using Automatic programmes

- Follow the instructions in the display.

### Using Fan plus

You can use any type of baking tray made of heat-resistant material.

Use this function if you are baking on several levels at the same time.

- 1 shelf level: place cakes in baking tins on shelf level 1.
- 1 shelf level: place flat items (e.g. biscuits, tray cakes) on shelf level 2.
- 2 shelf levels: depending on the height, place the food on shelf levels 1+3 or 2+3.

### Using Eco Fan heat

You can use any type of baking tray made of heat-resistant material.

Use this function for cooking bakes and gratins that need to be crispy on top.

- Place cakes or bakes in baking tins on shelf level 1.
- Place flat items (e.g. biscuits, tray cakes) on shelf level 2.

### Using MW + Fan plus

Use heat-resistant baking tins suitable for microwave use (see the requirements specified for crockery in the section on microwave operation), such as heat-resistant glass or ceramic dishes, as these allow microwaves through them.

The MW + Fan plus  function is particularly suitable for dough which requires a longer cooking duration, such as rubbed in, beaten mixtures and yeast recipes.

If you use this function, the cooking duration is shortened.

When selecting the microwave power level, observe the information in the cooking charts and in the recipes.

- Place the glass tray on shelf level 1.
- Place the baking tin on the glass tray.

**Tip:** Metal tins are less suitable for functions which use microwave power because the metal reflects the microwaves. The microwaves only reach the cake from above, which extends the cooking duration. If you use metal tins, place the tin on the glass tray so that it cannot touch the oven walls. If sparks form, do not reuse the tin for functions which use microwave power.



## Tips for roasting

- **Pre-heating** the oven compartment is only required when roasting beef sirloin joints and fillet. Pre-heating is generally not necessary.
- Use a **closed roasting dish** for roasting meat, such as an oven dish. The meat stays succulent. The oven compartment will also stay cleaner than when roasting on the rack. This ensures that sufficient stock remains for making gravy.
- If you are using a **roasting bag**, follow the instructions on the packaging.
- If you are using the **rack** or an **open roasting dish** for roasting, you can add a little fat or oil to very lean meat or place a few strips of streaky bacon on the top.
- **Season** the meat and place in the roasting dish. Dot with butter or margarine or brush with oil if necessary. For large lean cuts of meat (2–3 kg) and fatty poultry add about 1/8 l of water to the dish.
- Do not add too much liquid during cooking as this will hinder the **browning** process. Browning only occurs towards the end of the cooking duration. Remove the lid about halfway through the cooking duration if a more intensive browning result is desired.
- At the end of the programme, take the food out of the oven compartment, cover it and leave to **stand** for about 10 minutes. This helps retain juices when the meat is carved.
- For a crisp finish, baste **poultry** 10 minutes before the end of the cooking duration with slightly salted water.

## Notes on the cooking charts

You can find the cooking charts at the end of this book.

- Take note of the temperature range, microwave power levels, shelf levels and durations. These also take the type of cooking container, the size of the meat and cooking practices into account.

### Selecting the temperature

- As a general rule, select the lower temperature given in the chart. If higher temperatures are used, the meat will brown on the outside, but will not be properly cooked through.
- For cuts which weigh more than 3 kg, select a temperature approx. 10 °C lower than that given in the roasting chart. The roasting process will take longer, but the meat will cook evenly through and the skin or crackling will not be too thick.
- When roasting on the rack, set a temperature approx. 20 °C lower than for roasting in a covered oven dish.

### Selecting the cooking duration

Unless otherwise stated, the durations given in the cooking chart are for an oven compartment which has not been pre-heated.

# Roasting

- The traditional British method for calculating the roasting time is to allow 15 to 20 minutes per lb/ 450 grammes, according to type of meat, plus approx. 20 minutes, adjusting the length of time as roasting proceeds to obtain the required result. The roasting time can also be determined by multiplying the thickness of the roast [cm] with the time per cm [min/cm] stated below, depending on the type of meat:

- Beef/venison: 15–18 min/cm
- Pork/veal/lamb: 12–15 min/cm
- Sirloin/fillet: 8–10 min/cm

- As a general rule, check the food after the shortest duration.

## Tips

- For frozen meat, increase the cooking duration by approx. 20 minutes per kg.
- Frozen meat weighing less than approx. 1.5 kg does not need to be defrosted before roasting.

## Notes on the functions

You can find an overview of all the functions with their recommended values in “Main and sub-menus”.

### Using Automatic programmes

- Follow the instructions in the display.

### Using Fan plus or Auto roast

These functions are suitable for roasting meat, fish and poultry that needs to be well browned as well as sirloin joints and fillet.

In the Auto roast  function, the oven compartment heats initially to a high searing temperature (approx. 230 °C).

As soon as this temperature has been reached, the oven automatically drops the temperature back down to the pre-selected roasting temperature (continued roasting).

- For roasting, use crockery with heat-resistant handles such as an oven dish, roasting pan, Römertopf or a heat-resistant glass dish.
- Place the rack with the food on shelf level 1.

### Using MW + Fan plus or MW + Auto roast

These functions are **not** suitable for roasting delicate cuts of meat such as sirloin joints or fillet. The centre would be too well cooked before the exterior is browned.

Use the MW + Fan plus  function for rapid reheating and cooking of food, browning it at the same time. This function saves the most time and energy.

Use the MW + Auto roast  function for searing using a high temperature to start with, then continue cooking with a lower temperature.

If you use functions which use microwave power, the cooking duration is shortened.

When selecting the microwave power level, observe the information in the cooking charts and in the recipes.

- Dishes must be suitable for use in a microwave oven, must be heat-resistant and must not have metal lids (see “Suitable crockery for microwave use”).
- Place the rack together with the glass tray or the glass tray on shelf level 1.

 Risk of injury caused by hot surfaces.

If you grill with the door open, hot air will escape from the oven instead of being cooled by the cooling fan. The control elements will get hot.  
Grill with the oven door closed.

## Tips for grilling

- Pre-heating is necessary when grilling. For pre-heating, select a function which **does not use** microwave power.  
Pre-heat the grill element for approx. 5 minutes with the door closed.
- Trim the meat. Do not season the meat with salt before grilling as this draws the juices out.
- Add a little oil to lean meat if necessary. Do not use other types of fat as they can easily burn and cause smoke.
- Clean fish in the normal way. To enhance the flavour, season with a little salt. Fish can also be drizzled with lemon juice.
- Grill on the rack.
- To grill, brush the rack with oil and then place the food on the rack.

## Notes on the cooking charts

You can find the cooking charts at the end of this book.



- Take note of the temperature range, the shelf levels and the durations. These take the size of the meat and cooking practices into account.
- Check the food after the shortest duration quoted.

## Selecting the temperature

Select the temperature for the Fan grill  and MW + Fan grill  functions.

- As a general rule, select the lower temperature given in the chart. If higher temperatures are used, the meat will brown on the outside, but will not be properly cooked through.

## Selecting the grill level

Select between levels 1–3 for the Grill  and MW + Grill  functions.

- If you are grilling thicker foods further away from the grill element, select **Level 1**.
- If you desire a lighter, golden finish, on gratins for example, select **Level 2**.
- If you are quickly grilling thinner foods closer to the grill element, select **Level 3**.

# Grilling

## Selecting the cooking duration

- Grill thinner cuts of meat/slices of fish for approx. 6–8 minutes per side. It is best to grill food of a similar thickness at the same time so that the cooking duration does not vary too much.
- Grill thicker pieces for about 7–9 minutes per side.
- When grilling rolled meat, allow approx. 10 minutes per cm diameter.
- As a general rule, check the food after the shortest duration.
- To **test the food**, press down on the meat with a spoon. This lets you determine how well the meat has been cooked.
  - **Rare/rosé**  
If the meat gives easily to the pressure of the spoon, it will still be red on the inside.
  - **Medium**  
If there is some resistance, the inside will be pink.
  - **Well-done**  
If there is very little resistance, it is cooked through.

**Tip:** If the surface of a thicker cut of meat is browned but the centre is still raw, move the food to a lower level or reduce the temperature and continue grilling. This will stop the surface from becoming too dark.

## Notes on the functions

You can find an overview of all the functions with their recommended values in “Main and sub-menus”.

If you use functions which use microwave power, the cooking duration is shortened.

When selecting the microwave power level, observe the information in the grilling charts and in the recipes.

## Using Fan grill or MW + Fan grill

These functions are suitable for grilling thicker food, such as chicken.

A temperature setting of 220 °C is generally recommended for thinner types of food, 180–200 °C for thicker cuts.

- Place the rack on shelf level 1 or 2 depending on the height of the food.

## Using Grill or MW + Grill

These functions are suitable for grilling thin cuts of meat and browning food.

- Place the rack on shelf level 2 or 3 depending on the height of the food.

 Risk of injury caused by hot surfaces.

The oven gets hot during operation. You could burn yourself on the heating elements, oven compartment or accessories.

Allow the heating elements, oven compartment and the accessories to cool before manual cleaning.

 Risk of injury due to electric shock.

The steam from a steam cleaning appliance could reach live electrical components and cause a short circuit.

Do not use a steam cleaner to clean the oven.

All surfaces could be discoloured or damaged if unsuitable cleaning agents are used. The oven front is particularly susceptible to damage from oven cleaners.

All surfaces are susceptible to scratching. Scratches on glass can in some circumstances lead to breakage.

Remove all cleaning agent residues immediately.

Stubborn soiling could damage the oven in certain circumstances.

Once the oven has cooled, clean the oven compartment, the inside of the door and the door seal. Waiting too long can make cleaning unnecessarily difficult and in some cases impossible.

Operating a damaged oven can result in microwave leakage and present a hazard to the user.

Check the door and door seal for any sign of damage. If any damage is noticed, the oven should not be used again with microwave functions until the fault has been rectified by a service technician.

## Unsuitable cleaning agents

To avoid damaging the surfaces, do not use:

- Cleaning agents containing soda, ammonia, acids or chlorides
- Cleaning agents containing descaling agents on the front
- Abrasive cleaning agents (e.g. powder cleaners, scouring milk, scouring pads)
- Solvent-based cleaning agents
- Stainless steel cleaners
- Dishwasher cleaning agents
- Glass cleaning agents
- Cleaning agents for ceramic glass hobs
- Hard, abrasive brushes or sponges (e.g. pot scourers, brushes or sponges which have been previously used with abrasive cleaning agents)
- Stain remover eraser blocks
- Sharp metal scrapers
- Steel wool
- Spot cleaning with mechanical cleaning agents
- Oven cleaners \*
- Stainless-steel spiral pads

\* These can, however, be used to remove very heavy soiling from PerfectClean treated surfaces

## Cleaning and care

If soiling is left on for any length of time, it may become impossible to remove. If items are used frequently without being cleaned, it may become very difficult to clean them. It is therefore best to remove any soiling immediately.

Only the glass tray is dishwasher proof.

**Tip:** Soiling caused by spilt fruit juices and cake mixtures is best removed while the oven compartment is still warm.

To make it easier to clean the oven:

- Lower the grill element.
- To neutralise odours in the oven compartment, put a container of water with some lemon juice in the oven and heat for a few minutes.

### Removing normal soiling

Moisture inside the oven can cause damage.

Do not use too much water on the cloth or sponge and do not let water or any other liquid find its way into any oven compartment openings.

### Removing normal soiling

- Remove normal soiling immediately with warm water, washing-up liquid and a clean sponge or a clean, damp microfibre cloth.
- Remove all cleaning agent residues thoroughly with clean water. This is particularly important for any parts with a PerfectClean finish, as cleaning agent residues will impair the non-stick function.
- After cleaning, wipe the surfaces dry using a soft cloth.

### Removing stubborn soiling

Spilt fruit and roasting juices may cause lasting discolouration or matte patches on enamelled surfaces. This discolouration is permanent but will not affect the efficiency of the finish. Do not attempt to remove these marks. Clean these following the instructions given here.

- Moisten stubborn soiling with a solution of hot water and washing-up liquid and leave to soak for a few minutes.
- You can then also use the scouring pad on the back of a washing-up sponge to remove the soiling.

### Using oven cleaners

- Very stubborn soiling on PerfectClean surfaces can be cleaned using the Miele oven cleaner, which must only be applied to cold surfaces.

If the oven spray gets into gaps and openings, a strong odour is generated during subsequent cooking programmes.

Do not spray the oven cleaner onto the roof of the oven compartment.

Do not spray the oven cleaner into the gaps and openings of the oven compartment walls and rear wall.

- Follow the instructions on the packaging.

Oven cleaners from other manufacturers must only be used in a cold oven and for no longer than a maximum of 10 minutes.

- You can then also use the scouring pad on the back of a washing-up sponge to remove the soiling.
- Remove all cleaning agent residues thoroughly with clean water.
- Dry all surfaces with a soft cloth.

## Lowering the grill element

If the oven compartment roof is badly soiled, the grill element can be lowered to make cleaning easier. Clean the oven compartment roof regularly with a damp cloth or a dishwashing sponge.

 Risk of injury caused by hot surfaces.

The oven gets hot during operation. You could burn yourself on the heating elements, oven compartment or accessories.

Allow the heating elements, oven compartment and the accessories to cool before manual cleaning.

The oven compartment floor can be scratched by the falling nut.

Place a cloth over the oven compartment floor to protect it.

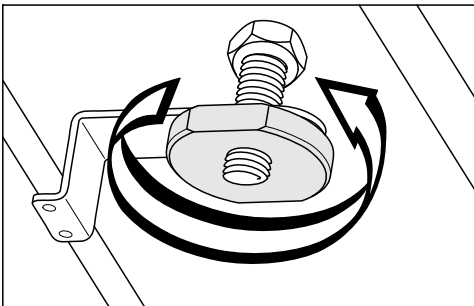

- Undo the nut.

The grill element can get damaged. Do not use force to lower the grill element.

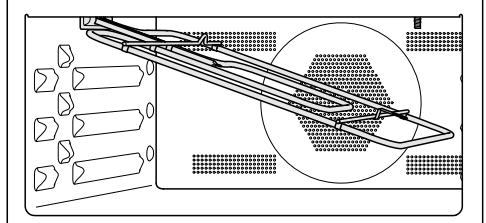

- Carefully lower the grill element.

The liner on the oven compartment roof can be damaged. Do not use the abrasive side of the dishwashing sponge to clean the roof liner.

The LED on the oven compartment roof can be damaged. Do not clean the LED if possible.

- Clean the oven compartment roof with a damp cloth or a dishwashing sponge.
- After cleaning, raise the grill element gently back up again.
- Replace the nut and tighten it securely.

## Problem solving guide

---

Many malfunctions and faults that can occur in daily operation can be easily remedied. You can save time and money in many cases, as you do not need to call the Miele Customer Service Department.





Information to help you rectify faults yourself can be found at [www.miele.com/service](http://www.miele.com/service).

The following tables are designed to help you to find the cause of a malfunction or a fault and to resolve it.

Problem	Cause and remedy
<b>The display is dark.</b>	You have selected the <b>Time   Display   Off</b> setting. When the oven is switched off, the display is dark. <ul style="list-style-type: none"><li>■ As soon as the oven is switched on, the main menu will appear. If you want the time of day to be displayed constantly, select the <b>Time   Display   On</b> setting.</li></ul>
	There is no power to the oven. <ul style="list-style-type: none"><li>■ Check that the oven plug is correctly inserted into the socket and switched on.</li><li>■ Check whether the circuit breaker has tripped. Contact a qualified electrician or the Miele Customer Service Department.</li></ul>
<b>The buzzer does not sound.</b>	The buzzers are deactivated or set at too low a volume. <ul style="list-style-type: none"><li>■ Switch on the buzzers or increase the volume with the <b>Volume   Buzzer tones</b> setting.</li></ul>
<b>The oven compartment does not heat up.</b>	Demo mode is active. You can select menu options in the display and the sensor controls, but the oven heating does not work. <ul style="list-style-type: none"><li>■ Deactivate demo mode with the <b>Showroom programme   Demo mode   Off</b> setting.</li></ul>
<b>You cannot start a cooking programme.</b>	The door is still open for a programme using microwave power. <ul style="list-style-type: none"><li>■ Check if the door is closed properly.</li></ul>
	A power level or a cooking duration is not set for a programme using microwave power. <ul style="list-style-type: none"><li>■ Make sure you have entered a microwave power level and a cooking duration.</li></ul>
	If you are cooking with a function which uses microwave power, not all of the required settings have been entered. <ul style="list-style-type: none"><li>■ Make sure you have entered a microwave power level, a cooking duration and a temperature.</li></ul>





# Problem solving guide

Problem	Cause and remedy
<p><b>The sensor controls do not respond.</b></p>	<p>You have selected the <b>Display   QuickTouch   Off</b> setting. When the oven is switched off, the sensor controls do not respond.</p> <ul style="list-style-type: none"> <li>■ As soon as the oven is switched on, the sensor controls will respond. If you want the sensor controls to respond even when the oven is switched off, select the <b>Display   QuickTouch   On</b> setting.</li> </ul> <p>The oven is not connected to the power supply.</p> <ul style="list-style-type: none"> <li>■ Check that the oven plug is correctly inserted into the socket and switched on.</li> <li>■ Check whether the fuse has tripped. Contact a qualified electrician or the Miele Customer Service Department.</li> </ul> <p>There is a fault with the controls.</p> <ul style="list-style-type: none"> <li>■ Touch and hold the  On/Off sensor control until the display switches off and the oven restarts.</li> </ul>
<p>System lock  <b>appears in the display when the oven is switched on.</b></p>	<p>The  system lock has been activated.</p> <ul style="list-style-type: none"> <li>■ Confirm with <b>OK</b>.</li> </ul> <p>Press “OK” for 6 secs will appear.</p> <ul style="list-style-type: none"> <li>■ You can deactivate the system lock for a cooking process by touching the <b>OK</b> sensor control for at least 6 seconds.</li> <li>■ If you want to permanently deactivate the system lock, select the <b>Safety   System lock    Off</b> setting.</li> </ul>
<p>Power cut <b>appears in the display.</b></p>	<p>There has been a brief power cut. This has caused the current cooking programme to stop.</p> <ul style="list-style-type: none"> <li>■ Switch the oven off and then back on again.</li> <li>■ Restart the cooking programme.</li> </ul>
<p>12:00 <b>appears in the display.</b></p>	<p>The power supply was interrupted for longer than 150 hours.</p> <ul style="list-style-type: none"> <li>■ Reset the time and date.</li> </ul>
<p>Max. op. hours reached <b>appears in the display.</b></p>	<p>The oven has been operating for an unusually long time. This has triggered the safety switch-off function.</p> <ul style="list-style-type: none"> <li>■ Confirm with <b>OK</b>.</li> </ul> <p>The oven is now ready to use.</p>
<p>Fault <b>and a fault code not listed here appears in the display.</b></p>	<p>A fault has occurred that you cannot resolve.</p> <ul style="list-style-type: none"> <li>■ Call the Miele Customer Service Department.</li> </ul>

## Problem solving guide

Problem	Cause and remedy
<p><b>If the door is opened while cooking with the Microwave function, the oven stops making noise.</b></p>	<p>This is not a fault. If the door is opened while cooking with the Microwave  function, the door contact switch will switch off the microwave oven and switch the cooling fan to a lower speed.</p>
<p><b>A noise can be heard after a cooking programme.</b></p>	<p>The cooling fan remains switched on after a cooking programme (see “Settings – Cooling fan run-on”).</p>
<p><b>An abnormal sound can be heard when the microwave oven is operating.</b></p>	<p>A metal dish has been used during a cooking programme using microwave power.</p> <ul style="list-style-type: none"> <li>■ Check if there are sparks caused by using metal dishes (see the requirements specified for crockery in the section on microwave operation).</li> </ul> <p>The food was covered with aluminium foil during a programme with microwave power.</p> <ul style="list-style-type: none"> <li>■ If necessary, remove the foil cover.</li> </ul> <p>The rack was used during a programme with microwave power.</p> <ul style="list-style-type: none"> <li>■ Always use the glass tray for programmes with microwave power.</li> </ul>
<p><b>The oven has switched itself off.</b></p>	<p>To save power, the oven switches off automatically if a button is not pressed after a certain amount of time or after a cooking programme has ended.</p> <ul style="list-style-type: none"> <li>■ Switch the oven back on.</li> </ul>
<p><b>Cakes/biscuits are not cooked properly after the duration given in the cooking chart.</b></p>	<p>A different temperature from the one given in the recipe was used.</p> <ul style="list-style-type: none"> <li>■ Select the temperature required for the recipe.</li> </ul> <p>The ingredient quantities are different from those given in the recipe.</p> <ul style="list-style-type: none"> <li>■ Check whether you amended the recipe. The addition of more liquid or more eggs makes a moister mix which requires a longer cooking duration.</li> </ul>

## Problem solving guide

Problem	Cause and remedy
<b>The browning is uneven.</b>	<p>The wrong temperature or shelf level was selected.</p> <ul style="list-style-type: none"> <li>■ There will always be a slight unevenness in browning. If browning is very uneven, check whether the correct temperature and shelf level were selected.</li> </ul>
	<p>The material or colour of the baking tin is not suitable for the function selected. Light-coloured, shiny or thin-walled tins are less suitable. These reflect the oven's heat, which means that the heat does not penetrate to the food effectively, resulting in uneven or poor browning.</p> <ul style="list-style-type: none"> <li>■ Dark matt tins are best for baking.</li> </ul>
<b>The food is not sufficiently heated or is not cooked at the end of a set duration when using the  function.</b>	<p>Check whether the programme using microwave power has been interrupted and has not restarted.</p> <ul style="list-style-type: none"> <li>■ Restart the cooking programme to ensure the food is heated or cooked properly.</li> </ul>
	<p>When cooking or reheating with microwave power, the time set was too short.</p> <ul style="list-style-type: none"> <li>■ Check that the correct duration is selected for the microwave power level. The lower the microwave power level the longer the cooking duration.</li> </ul>
<b>Food has cooled down too quickly after being reheated or cooked using microwave power.</b>	<p>In the microwave oven, food begins to cook from the outside first, the inside of the food relying on the slower conduction of heat. If food is cooked at a high microwave power level, it is possible that the heat may not have reached the centre of the food, so it is hot on the outside but cold in the centre. During the standing time, the heat is transferred to the centre of the food.</p> <ul style="list-style-type: none"> <li>■ When heating food with different densities, such as with menu cooking, it is sensible to start with a low microwave power level and select a longer reheating duration.</li> </ul>
<b>The oven interior lighting switches off after a short time.</b>	<p>You have selected the Lighting   "On" for 15 seconds setting.</p> <ul style="list-style-type: none"> <li>■ If you want the oven interior lighting to be switched on during the entire cooking programme, select the Lighting   On setting.</li> </ul>
<b>The oven interior lighting is off or does not switch on.</b>	<p>You have selected the Lighting   Off setting.</p> <ul style="list-style-type: none"> <li>■ Press the  sensor control to switch on the oven interior lighting for 15 seconds.</li> <li>■ If required, select the Lighting   On or "On" for 15 seconds setting.</li> </ul>
	<p>The oven interior lighting is faulty.</p> <ul style="list-style-type: none"> <li>■ Call the Miele Customer Service Department.</li> </ul>

# Service

---

Information to help you rectify faults yourself and about Miele spare parts can be found at [www.miele.com/service](http://www.miele.com/service).

## Contact in the event of a fault

In the event of any faults which you cannot remedy yourself, please contact your Miele dealer or the Miele Customer Service Department.

You can book a Miele Customer Service Department call-out online at [www.miele.com/service](http://www.miele.com/service).

Contact information for the Miele Customer Service Department can be found at the end of this document.

Please quote the model identifier and serial number of your appliance (Fabr./SN/Nr.) when contacting the Miele Customer Service Department. This information can be found on the data plate.

Please note that telephone calls may be monitored and recorded for training purposes and that a call-out charge will be applied to service visits where the problem could have been resolved as described in this booklet.

This information is given on the data plate, which is visible on the front frame of the oven when the door is fully open.

## Warranty

For information on the appliance warranty specific to your country please contact Miele. See back cover for address.

In the UK, your appliance warranty is valid for 2 years from the date of purchase. However, you must activate your cover by calling 0330 160 6640 or registering online at [www.miele.co.uk](http://www.miele.co.uk).

## Installation dimensions

Dimensions are given in mm.

### Installation in a tall or base unit

When building the oven into a base unit underneath a hob, please also observe the installation instructions for the hob as well as the building-in depth required for the hob.

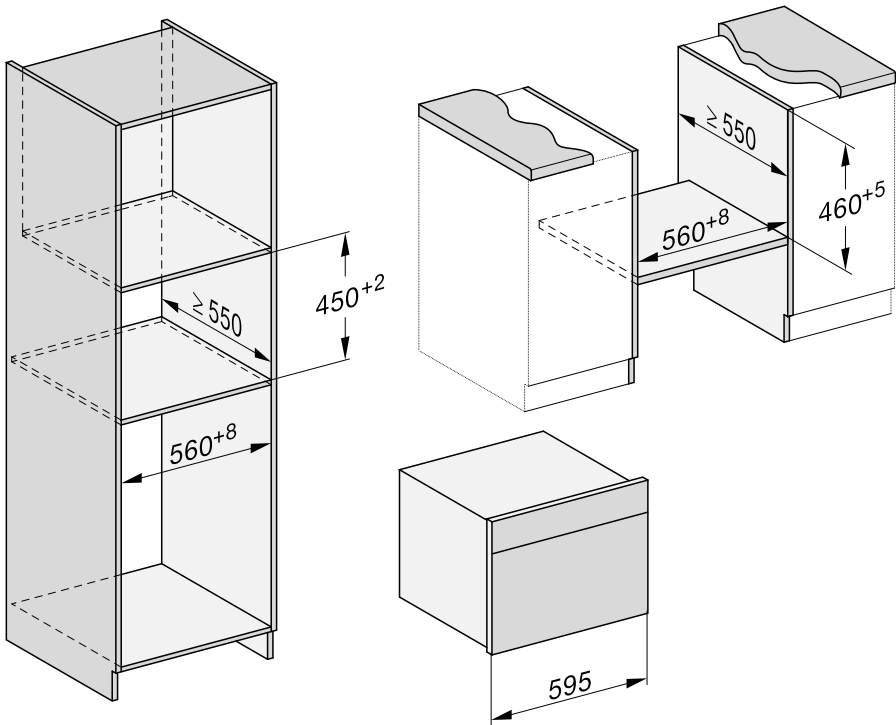

# Installation

## Side view

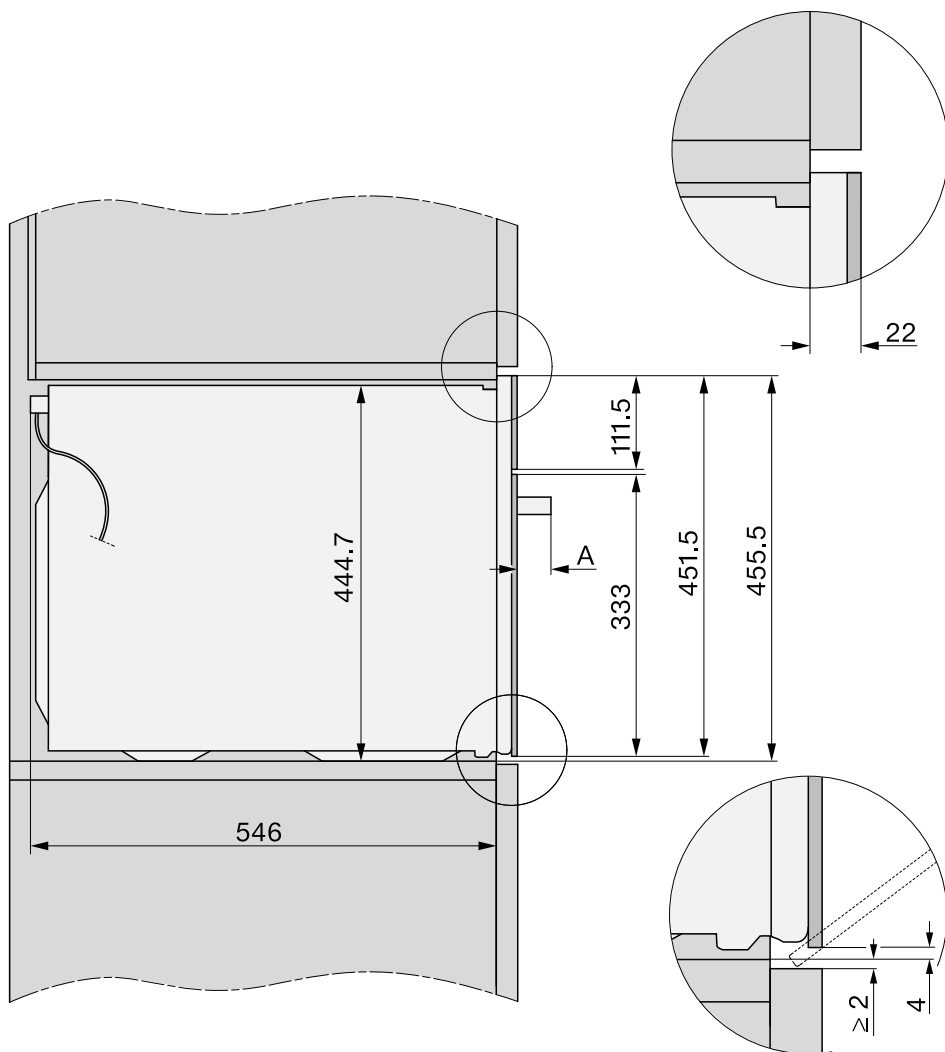

**A** H 71xx: 43 mm

H 72xx: 47 mm

## Connections and ventilation

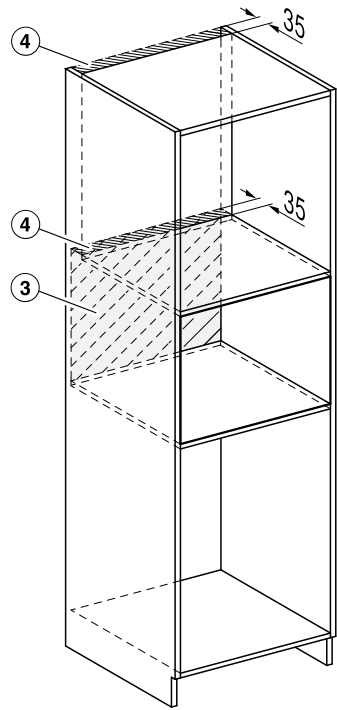
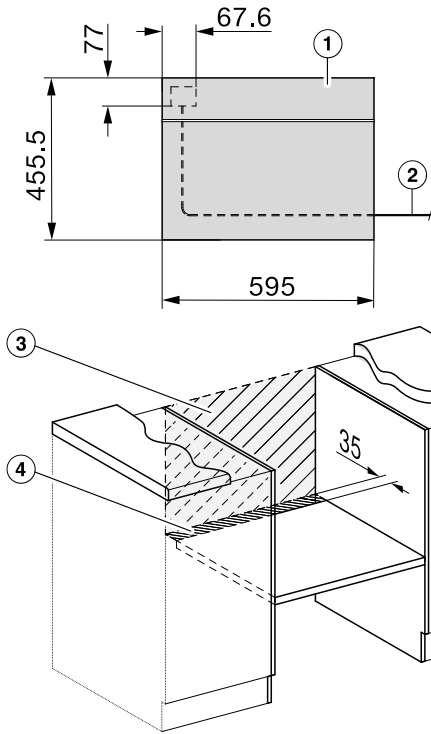

- ① Front view
- ② Mains connection cable, length = 2000 mm
- ③ No connections permitted in this area
- ④ Ventilation cut-out, min. 150 cm<sup>2</sup>

# Installation

---

## Installing the oven

- Connect the oven to the electrical supply.
- Push the oven into the housing unit and align it.

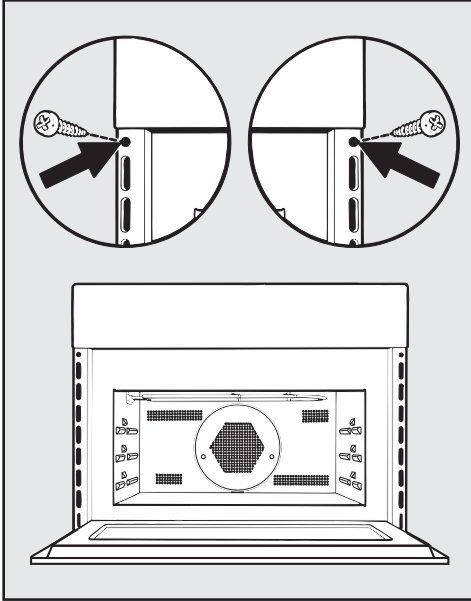

- Open the door and use the screws supplied to secure the oven to the side walls of the housing unit.



## Electrical connection

The oven is equipped with a mains connection cable and plug for connection to a 50 Hz, 230 V alternating current supply.

The fuse rating must be at least 16 A.

The appliance must only be connected to a correctly installed earthed socket. The electrical installation must comply with VDE 0100 requirements.

Ensure that the plug and switch are accessible at all times.

If the appliance is hardwired or if the switch is not accessible after installation, an additional means of disconnection means must be provided.

Suitable means of disconnection include accessible switches with an all-pole contact gap of at least 3 mm. These include circuit breakers, fuses and contactors (EN 60335).

**Connection data** is given on the data plate situated at the front of the oven compartment. Please ensure the connection data matches the household supply.

When contacting Miele, please quote the following:

- Model identifier
- Serial number
- Connection data (mains voltage/frequency/maximum rated load)

If the mains connection cable is damaged, a new one must be fitted by a service technician authorised by the Miele Customer Service Department.

This compact microwave combination oven complies with European standard EN 55011. It is classified as a Group 2, class B appliance.

















Group 2 appliances use high frequency energy in the form of electromagnetic waves to create heat in food.

Class B is assigned to appliances that are suitable for domestic use.

Temporary or permanent operation on an autonomous power supply system or a power supply system that is not synchronised with the mains power supply (e.g. island networks, back-up systems) is possible. A prerequisite for operation is that the power supply system complies with the specifications of EN 50160 or an equivalent standard. The function and operation of the protective measures provided in the domestic electrical installation and in this Miele product must also be maintained in isolated operation or in operation that is not synchronised with the mains power supply, or these measures must be replaced by equivalent measures in the installation. As described, for example, in the current version of VDE-AR-E 2510-2.

# Cooking charts

## Batter

Cakes/biscuits (accessories)		 +  [°C] + [W]		 <sup>3</sup> <sub>1</sub>	 [min]
Muffins		150–160	✓	2	35–45
Small cakes (1 glass tray)*		150	–	2	25–35
Small cakes (2 glass trays)*		140	–	2+3	35–45
Madeira cake (loaf tin, 30 cm)	 <sup>1</sup>	160–170 + 80	✓	1	35–45
Ring cake (ring tin/Bundt cake tin, Ø 26 cm)	 <sup>1</sup>	160–170 + 150	✓	1	40–50
Marble, nut cake (loaf tin, 30 cm)		150–160	✓	1	65–75
Marble, nut cake (ring tin/Bundt cake tin, Ø 26 cm)		150–160	✓	1	55–65
Fresh fruit cake (1 glass tray)		150–160	✓	2	50–60
Fresh fruit cake (springform cake tin, Ø 26 cm)		150–160	✓	1	55–65
Flan base (flan base tin, Ø 28 cm)		150–160	✓	1	25–35















 Operating mode,  Temperature,  Microwave power level,  Booster, <sup>3</sup><sub>1</sub> Shelf level,  Cooking duration,  Fan plus, <sup>1</sup> MW + Fan plus, ✓ On, – Off







\* The settings also apply for testing in accordance with EN 60350-1.

<sup>1</sup> Place the baking tin in the centre of the glass tray.

<sup>2</sup> Pre-heat the oven before putting food inside.

## Shortcrust pastry

Cakes/biscuits (accessories)		 [°C]		 3 1	 [min]
Biscuits (1 glass tray)		140–150	✓	2	20–30
Drop cookies (1 glass tray)*		140	–	2	40–50
Drop cookies (2 glass trays)*		140	–	2+3	45–55 <sup>2</sup>
Flan base (flan base tin, Ø 28 cm)		150–160	✓	2	30–40
Cheesecake (springform cake tin, Ø 26 cm)		150–160	✓	1	75–85
Apple pie, single crust (springform cake tin, Ø 20 cm)*		160	–	1	110–120
Apple pie, double crust (springform cake tin, Ø 26 cm)		150–160	✓	1	65–75
Fresh fruit cake, glazed (springform cake tin, Ø 26 cm)		150–160	✓	1	60–70
Fresh fruit cake, with meringue topping (1 glass tray)		150–160	✓	2	55–65
Sweet flan (1 glass tray)		190–200 <sup>1</sup>	✓	2	30–40

 Operating mode,  Temperature,  Booster,  Shelf level,  Cooking duration,  Fan plus, ✓ On, – Off

















\* The settings also apply for testing in accordance with EN 60350-1.







1 Pre-heat the oven before putting food inside.

2 Take the trays out of the oven early if the food is sufficiently browned before the specified cooking duration has elapsed.









# Cooking charts







## Yeast dough

Cakes/biscuits (accessories)		 +  [°C] + [W]		 <sup>3</sup> <sub>1</sub>	 [min]
Bundt cake (Bundt cake tin, Ø 24 cm)		140–150	✓	1	55–65
Stollen (1 glass tray)		150–160	✓	1	60–70
Streusel cake with/without fruit (1 glass tray)		160–170	✓	2	40–50
		170–180 + 150	–	2	30–40
Fresh fruit cake (1 glass tray)		160–170	✓	2	40–50
		170–180 + 150	–	2	25–35
Apple turnovers/raisin whirls (1 glass tray)		150–160	✓	2	25–35
White bread (free-form) (1 glass tray)		180–190	–	2	35–45
White bread (loaf tin, 30 cm)		190–200	✓	1	50–60
Wholegrain bread (loaf tin, 30 cm)		180–190	✓	1	55–65
Proving yeast dough (bowl)		35	–	1	30









 Operating mode,  Temperature,  Booster, <sup>3</sup><sub>1</sub> Shelf level,  Cooking duration,  Fan plus,  MW + Fan plus, ✓ On, – Off









## Quark dough

Cakes/biscuits (accessories)		 +  [°C] + [W]		 <sup>3</sup> <sub>1</sub>	 [min]
Fresh fruit cake (1 glass tray)		160–170	✓	2	40–50
		170–180 + 150	–	2	25–35
Apple turnovers/raisin whirls (1 glass tray)		150–160	✓	2	25–35

 Operating mode,  Temperature,  Booster, <sup>3</sup><sub>1</sub> Shelf level,  Cooking duration,  Fan plus,  MW + Fan plus, ✓ On, – Off

## Sponge mixture













Cakes/biscuits (accessories)		 [°C]		 3 1	 [min]
Sponge cake base (2 eggs, springform cake tin, Ø 26 cm)		170–180 <sup>1</sup>	–	1	15–25
Sponge cake base (4 eggs, springform cake tin, Ø 26 cm)		170–180 <sup>1</sup>	–	1	30–40
Whisked sponge (springform cake tin, Ø 26 cm)*		190	–	2	20–30
Swiss roll sponge (1 glass tray)		170–180 <sup>1</sup>	–	2	12–22









 Operating mode,  Temperature,  Booster,  Shelf level,  Cooking duration,  Fan plus,  On,  Off

\* The settings also apply for testing in accordance with EN 60350-1.

<sup>1</sup> Pre-heat the oven before putting food inside.















## Choux pastry, puff pastry, meringue









Cakes/biscuits (accessories)		 [°C]		 3 1	 [min]
Choux buns (1 glass tray)		160–170		2	30–40
Pastry puffs (1 glass tray)		170–180		2	25–35
Macaroons (1 glass tray)		120–130		2	35–45
Meringues/pavlovas (1 glass tray, 1 tray of 6 Ø 6 cm)		80–100	–	2	120–150

 Operating mode,  Temperature,  Booster,  Shelf level,  Cooking duration,  Fan plus,  On,  Off

# Cooking charts

## Savoury dishes

Food (accessories)		 +  [°C] + [W]		 <sup>3</sup> <sub>1</sub>	 [min]
Savoury flan (1 glass tray)		190-200 <sup>2</sup>	✓	2	30-40
Onion tart (1 glass tray)		180- 190 + 150	-	2	30-40
Pizza, yeast dough (1 glass tray)		160-170 + 80	-	2	25-35
Pizza, quark dough (1 glass tray)		150-160	-	2	25-35
Toast* (wire rack)	 <sup>1</sup>	3 <sup>3</sup>	-	2	2-4
Baked dishes/gratins (e.g. toast) (wire rack on the glass tray)	 <sup>1</sup>	3	-	2	5-9
Grilled vegetables (wire rack on the glass tray)	 <sup>1</sup>	3 <sup>3</sup>	-	2	10-12 <sup>4</sup>
		210-220 <sup>3</sup>	-	2	8-10 <sup>4</sup>











 Operating mode,  Temperature,  Booster, <sup>3</sup><sub>1</sub> Shelf level,  Cooking duration,  Fan plus,  MW + Fan plus,  Full grill,  Fan grill, ✓ On, - Off









\* The settings also apply for testing in accordance with EN 60350-1.

- 1 Select the specified grill level.
- 2 Pre-heat the oven before putting food inside.
- 3 Pre-heat the oven for 5 minutes before putting food inside.
- 4 Turn the food halfway through cooking.

# Cooking charts

## Beef

Food (accessories)		 [°C]		 <sup>3</sup> <sub>1</sub>	 [min]	 <sup>8</sup> [°C]
Braised beef, approx. 1 kg (roasting dish with lid)	 <sup>2</sup>	150–160	✓	1	120–130 <sup>6</sup>	–
Fillet of beef, approx. 1 kg <sup>1</sup>	 <sup>2</sup>	150–160 <sup>4</sup>	–	1	30–70	45–75
Sirloin joint, approx. 1 kg <sup>1</sup>	 <sup>2</sup>	150–160 <sup>4</sup>	✓	1	25–70	45–75
Burgers <sup>*1</sup>	 <sup>3</sup>	3 <sup>5</sup>	–	2	1: 17–22 2: 5–10 <sup>7</sup>	–
Meat patties <sup>1</sup>	 <sup>3</sup>	3 <sup>5</sup>	–	2	1: 10–15 2: 5–10 <sup>7</sup>	–

 Operating mode,  Temperature,  Booster, <sup>3</sup><sub>1</sub> Shelf level,  Cooking duration, <sup>8</sup> Core temperature,  Fan plus,  Full grill, ✓ On, – Off

\* The settings also apply for testing in accordance with EN 60350-1.

<sup>1</sup> Use the wire rack and glass tray.

<sup>2</sup> Sear the meat on the hob first.

<sup>3</sup> Select the specified grill level.

<sup>4</sup> Pre-heat the oven before putting food inside.











<sup>5</sup> Pre-heat the oven for 5 minutes before putting food inside.









<sup>6</sup> Roast with the lid on to start with. Remove the lid 60 minutes into the cooking duration and add approx. 0.5 litres of liquid.

<sup>7</sup> Turn the food once it has browned sufficiently (1: grill duration side 1, 2: grill duration side 2).

<sup>8</sup> If you have a separate food probe you can use the core temperature shown.

## Veal

Food (accessories)		 +  [°C] + [W]		 <sup>3</sup> <sub>1</sub>	 [min]	 <sup>3</sup> [°C]
Braised veal, approx. 1.5 kg (roasting dish with lid)	 <sup>1</sup>	160–170	✓	1	120–130 <sup>2</sup>	–
	 <sup>1</sup>	160–170 + 150	✓	1	80–90 <sup>2</sup>	–
Fillet of veal, approx. 1 kg (glass tray)	 <sup>1</sup>	150–160	✓	1	20–50	45–75

 Operating mode,  Temperature,  Booster, <sup>3</sup><sub>1</sub> Shelf level,  Cooking duration, <sup>3</sup> Core temperature,  Fan plus,  MW + Fan plus, ✓ On, – Off













<sup>1</sup> Sear the meat on the hob first.

<sup>2</sup> Roast with the lid on to start with. Remove the lid 60 minutes into the cooking duration and add approx. 0.5 litres of liquid.

<sup>3</sup> If you have a separate food probe you can use the core temperature shown.

# Cooking charts

## Pork













Food (accessories)		 +  [°C] + [W]		 <sup>3</sup>	 [min]	 <sup>7</sup> [°C]
Pork joint/pork neck roast, approx. 1 kg (roasting dish with lid)	 <sup>1</sup>	160–170 + 150	✓	1	80–90 <sup>4</sup>	80–90
Pork joint with crackling, approx. 2 kg (roasting dish)	 <sup>1</sup>	170–180 + 150	✓	1	70–80 <sup>5</sup>	80–90
Gammon joint, approx. 1 kg (glass tray)		170–180 + 150	–	1	40–50	63–68
Meat loaf, approx. 1 kg (glass tray)		170–180 + 150	–	1	35–45 <sup>5</sup>	80–85
Bacon (wire rack on the glass tray)	 <sup>2</sup>	3 <sup>3</sup>	–	2	5–10	–
Sausages (wire rack on the glass tray)	 <sup>2</sup>	3 <sup>3</sup>	–	2	15–20 <sup>6</sup>	–









 Operating mode,  Temperature,  Booster, <sup>3</sup> Shelf level,  Cooking duration, <sup>7</sup> Core temperature,  MW + Auto roast,  MW + Fan plus,  Full grill, ✓ On, – Off

- 1 Use crockery that is microwave safe.
- 2 Select the specified grill level.
- 3 Pre-heat the oven for 5 minutes before putting food inside.
- 4 Roast with the lid on to start with. Remove the lid 60 minutes into the cooking duration and add approx. 0.5 litres of liquid.
- 5 Add approx. 0.5 litres of liquid halfway through the cooking duration.
- 6 Turn the food halfway through cooking.
- 7 If you have a separate food probe you can use the core temperature shown.



## Lamb, game

Food (accessories)		 +  [°C] + [W]		 <sup>3</sup>	 [min]	 <sup>4</sup> [°C]
Leg of lamb on the bone, approx. 1.5 kg (roasting dish with lid)		170–180 + 80	✓	1	100–120 <sup>3</sup>	64–82
Saddle of lamb, off the bone (wire rack on the glass tray)	 <sup>1</sup>	170–180 <sup>2</sup>	✓	1	15–40	53–80
Saddle of venison, off the bone (roasting dish)	 <sup>1</sup>	170–180 <sup>2</sup>	✓	1	45–75	60–81
Saddle of roebuck, off the bone (glass tray)	 <sup>1</sup>	140–150 <sup>2</sup>	–	1	20–40	60–81
Leg of wild boar, off the bone, approx. 1 kg (roasting dish with lid)		180–190	✓	1	90–120 <sup>3</sup>	80–90

 Operating mode,  Temperature,  Booster, <sup>3</sup> Shelf level,  Cooking duration, <sup>4</sup> Core temperature,  MW + Auto roast,  Fan plus,  Auto roast, ✓ On, – Off

- 1 Sear the meat on the hob first.
- 2 Pre-heat the oven before putting food inside.
- 3 Roast with the lid on to start with. Remove the lid 60 minutes into the cooking duration and add approx. 0.5 litres of liquid.
- 4 If you have a separate food probe you can use the core temperature shown.

# Cooking charts

## Poultry, fish













Food (accessories)		+ [°C] + [W]		<sup>3</sup> 1	 [min]	<sup>4</sup> [°C]
Poultry, 0.8–1.5 kg (wire rack on the glass tray)		160–170	✓	1	55–65	85–90
		170–180 + 150	–	1	40–50	85–90
Chicken, approx. 1.2 kg (wire rack on the glass tray)		180–190 <sup>1</sup>	–	1	60–70 <sup>2</sup>	85–90
	*	200 + 150	–	1	45–55 <sup>2</sup>	85–90
Poultry, approx. 2 kg (shallow ovenproof dish on the glass tray)		160–170	✓	1	110–140	85–90
		170–180 + 80	–	1	100–120	85–90
Poultry, approx. 4 kg (roasting dish on the glass tray)		160–170 + 80	–	1	150–160 <sup>3</sup>	90–95
Fish, 200–300 g (e.g. trout) (glass tray)		160–170 + 150	–	1	15–25	75–80
Fish, 1–1.5 kg (e.g. salmon trout) (glass tray)		160–170 + 150	–	1	20–30	75–80







Operating mode, Temperature, Booster, <sup>3</sup> Shelf level, Cooking duration, <sup>4</sup> Core temperature, Auto roast, MW + Auto roast, Fan grill, MW + Fan grill, MW + Fan plus, ✓ On, – Off

\* The settings also apply for testing in accordance with EN 60705.

- 1 Pre-heat the oven for 5 minutes before putting food inside.
- 2 Turn the food half way through grilling.
- 3 Add approx. 0.5 litres of liquid after 30 minutes.
- 4 If you have a separate food probe you can use the core temperature shown.

## Test food according to EN 60350-1











Test food (accessories)		 [°C]		 <sup>3</sup>	 [min]
Small cakes (1 glass tray <sup>1</sup> )		150	-	2	25–35
Small cakes (2 glass trays <sup>1</sup> )		140	-	2+3	35–45
Drop cookies (1 glass tray <sup>1</sup> )		140	-	2	40–50
Drop cookies (2 glass trays <sup>1</sup> )		140	-	2+3	45–55 <sup>5</sup>
Apple pie (wire rack <sup>1</sup> , springform cake tin <sup>2</sup> , Ø 20 cm)		160	-	1	110–120
Whisked sponge (wire rack <sup>1</sup> , springform cake tin <sup>2</sup> , Ø 26 cm)		190	-	2	20–30
Toast (wire rack <sup>1</sup> )	 <sup>3</sup>	3 <sup>4</sup>	-	2	2–4
Burgers (wire rack <sup>1</sup> on the glass tray <sup>1</sup> )	 <sup>3</sup>	3 <sup>4</sup>	-	2	1: 17–22 2: 5–10 <sup>6</sup>

 Operating mode,  Temperature,  Booster, <sup>3</sup> Shelf level,  Cooking duration,  
 Fan plus, <sup>3</sup> Full grill, ✓ On, – Off

- 1 Only use original Miele accessories.
- 2 Use a dark matt springform cake tin.  
Place the springform cake tin centrally on the wire rack.
- 3 Select the specified grill level.
- 4 Pre-heat the oven for 5 minutes before putting food inside.
- 5 Take the trays out of the oven early if the food is sufficiently browned before the specified cooking duration has elapsed.
- 6 Turn the food once it has browned sufficiently (1: grill duration side 1, 2: grill duration side 2).

# Notes for test institutes

## Test food in accordance with EN 60705 (microwave operating mode )

Test food		 [W]	 [min]	 <sup>2</sup> [min]	Notes <sup>3</sup>
Custard, 1000 g		600 + 450	6 + 15–18	120	Crockery see Standard, dimensions at the upper rim 250 mm x 250 mm, cook uncovered
Madeira cake, 475 g		450	8–11	5	Crockery see Standard, external diameter at the upper rim 220 mm, cook uncovered
Minced meat, 900 g		600 + 450	8 + 12	5	Crockery see Standard, dimensions at the upper rim 250 mm x 124 mm, cook uncovered
Potato gratin, 1100 g		300 + 170 °C	25–35	5	Crockery see Standard, external diameter at the upper rim 220 mm, cook uncovered
Chicken, 1200 g		150 + 200 °C	45–55 <sup>1</sup>	2	Place the chicken on the wire rack with the breast facing down to start with and slide the wire rack into the oven compartment on top of the glass tray.
Defrost meat, (minced meat), 500 g		150	16–19 <sup>1</sup>	10	Crockery see Standard, defrost uncovered
Raspberries, 250 g		150	6–8	3	Crockery see Standard, defrost uncovered

 Operating mode,  Microwave power level,  Defrost or cooking duration,  Standing time,  Microwave,  MW + Fan plus,  MW + Fan grill

- 1 Turn the food halfway through cooking/defrosting.
- 2 Allow the food to stand at room temperature for the standing time<sup>3</sup> quoted to enable the heat to spread evenly throughout the food.
- 3 Slide the glass tray into the oven on shelf 1 and place the crockery in the centre of it.

# Conformity declaration

## EU Conformity declaration

Miele hereby declares that this oven complies with Directive 2014/53/EU.

The complete text of the EU declaration of conformity is available from one of the following internet addresses:

- Products, Download from [www.miele.ie](http://www.miele.ie)
- For service, information, operating instructions etc: go to <https://miele.co.uk/manuals> and enter the name of the product or the serial number

Frequency range of the WiFi module	2.4000–2.4835 GHz
------------------------------------	-------------------

Maximum transmission power of the WiFi module	< 100 mW
---	----------

## UK Conformity declaration

Miele hereby declares that this oven complies with UK Radio Equipment Regulations 2017, as amended.

The complete text of the UK declaration of conformity is available from one of the following internet addresses:

- Products, Download from [www.miele.co.uk](http://www.miele.co.uk)
- For service, information, operating instructions etc: go to <https://miele.co.uk/manuals> and enter the name of the product or the serial number

Frequency range of the WiFi module	2.4000–2.4835 GHz
------------------------------------	-------------------

Maximum transmission power of the WiFi module	< 100 mW
---	----------

# Copyrights and licences for the communication module

---

For the purpose of operating and controlling the communication module, Miele uses proprietary or third-party software that is not covered by open source licensing terms. These items of software/software components are protected by copyright. The copyrights held by Miele and third parties must be respected.

Furthermore, this communication module contains software components which are distributed under open source licence conditions. The open source components contained in the appliance along with the corresponding copyright notices, copies of the licensing terms valid at the time, and any further information can be accessed locally via IP using a web browser (*<http://<IP address>/Licenses>*). The liability and warranty arrangements for the open source licences displayed in this location only apply in relation to the respective rights holders.

## United Kingdom

Miele Co. Ltd., Fairacres, Marcham Road, Abingdon, Oxon, OX14 1TW  
Tel: 0330 160 6600, Internet: [www.miele.co.uk](http://www.miele.co.uk), E-mail: [info@miele.co.uk](mailto:info@miele.co.uk)

### Australia

Miele Australia Pty. Ltd.  
ACN 005 635 398  
ABN 96 005 635 398  
Level 4, 141 Camberwell Road  
Hawthorn East, VIC 3123  
Tel: 1300 464 353  
E-mail: [info@miele.com.au](mailto:info@miele.com.au)  
Internet: [www.miele.com.au](http://www.miele.com.au)

### China Mainland

Miele Electrical Appliances Co., Ltd.  
1-3 Floor, No. 82 Shi Men Yi Road  
Jing' an District  
200040 Shanghai, PRC  
Tel: +86 21 6157 3500  
Fax: +86 21 6157 3511  
E-mail: [info@miele.cn](mailto:info@miele.cn)  
Internet: [www.miele.cn](http://www.miele.cn)

### Hong Kong, China

Miele (Hong Kong) Ltd.  
41/F - 4101, Manhattan Place  
23 Wang Tai Road  
Kowloon Bay, Hong Kong  
Tel: (852) 2610 1025  
Fax: (852) 3579 1404  
E-mail: [customerservices@miele.com.hk](mailto:customerservices@miele.com.hk)  
Website: [www.miele.hk](http://www.miele.hk)

### India

Miele India Pvt. Ltd.  
1st Floor, Copia Corporate Suites,  
Commercial Plot 9,  
Mathura Road, Jasola,  
New Delhi - 110025  
E-mail: [customercare@miele.in](mailto:customercare@miele.in)  
Website: [www.miele.in](http://www.miele.in)

**Manufacturer:** Miele & Cie. KG, Carl-Miele-Straße 29, 33332 Gütersloh, Germany

### Ireland

Miele Ireland Ltd.  
2024 Bianconi Avenue  
Citywest Business Campus  
Dublin 24  
Tel: (01) 461 07 10  
Fax: (01) 461 07 97  
E-mail: [info@miele.ie](mailto:info@miele.ie)  
Internet: [www.miele.ie](http://www.miele.ie)

### Kuwait

Miele Kuwait  
Al Wazzan United Trading Co.  
P. O. Box : 3379  
Hawally, 32034 Kuwait  
Tel.: 00965-22001010  
Fax: 00965-24838292  
E-mail: [mail@alwazzanunited.com](mailto:mail@alwazzanunited.com)  
Website: [www.alwazzanunited.com](http://www.alwazzanunited.com)

### Malaysia

Miele Sdn Bhd  
Suite 12-2, Level 12  
Menara Sapura Kencana  
Petroleum  
Solaris Dutamas No. 1  
Jalan Dutamas 1  
50480 Kuala Lumpur, Malaysia  
Phone: +603-6209-0288  
Fax: +603-6205-3768

### New Zealand

Miele New Zealand Limited  
IRD 98 463 631  
8 College Hill  
Freemans Bay, Auckland 1011  
Tel: 0800 464 353  
E-mail: [customercare@miele.co.nz](mailto:customercare@miele.co.nz)  
Internet: [www.miele.co.nz](http://www.miele.co.nz)

### Singapore

Miele Pte. Ltd.  
29 Media Circle  
#11-04 ALICE@Mediapolis  
Singapore 138565  
Tel: +65 6735 1191  
Fax: +65 6735 1161  
E-mail: [info@miele.com.sg](mailto:info@miele.com.sg)  
Internet: [www.miele.sg](http://www.miele.sg)

### South Africa

Miele (Pty) Ltd.  
63 Peter Place, Bryanston 2194  
P.O. Box 69434, Bryanston 2021  
Tel: (011) 875 9000  
Fax: (011) 875 9035  
E-mail: [info@miele.co.za](mailto:info@miele.co.za)  
Internet: [www.miele.co.za](http://www.miele.co.za)

### Thailand

Miele Appliances Ltd.  
BHIRAJ TOWER at EmQuartier  
43rd Floor Unit 4301-4303  
689 Sukhumvit Road  
North Klongton Sub-District  
Vadhana District  
Bangkok 10110, Thailand

### United Arab Emirates

Miele Appliances Ltd.  
Showroom 1, Eiffel 1 Building  
Sheikh Zayed Road, Umm Al Sheif  
P.O. Box 114782 - Dubai  
Tel. +971 4 3044 999  
Fax. +971 4 3418 852  
800-MIELE (64353)  
E-mail: [info@miele.ae](mailto:info@miele.ae)  
Website: [www.miele.ae](http://www.miele.ae)

H 7140 BM, H 7145 BM, H 7240 BM