







Operating and installation instructions Cooker hood



To prevent the risk of accidents or damage to the appliance, it is **essential** to read these instructions before it is installed and used for the first time.

Contents

Warning and Safety instructions	4
Caring for the environment	12
Modes of operation	13
Fragrance.....	13
Operating the appliance with the Miele@mobile app.....	13
Guide to the cooker hood	14
Before using for the first time	16
Setting up Miele@home	16
Connecting via the app	17
Connecting via WPS	18
Sign out of WiFi (reset to factory settings)	19
Setting up Con@ctivity	20
Con@ctivity via the home WiFi network (Con@ctivity 3.0)	20
Con@ctivity via a direct WiFi connection (Con@ctivity 3.0)	21
Reattempting the connection	21
Operation (Automatic mode)	22
Cooking with Con@ctivity (Automatic mode).....	22
Cooking process	23
Leaving automatic mode temporarily	24
Returning to automatic mode.....	24
Operation (Manual mode)	25
Cooking without Con@ctivity (Manual mode)	25
Switching the fan on and off 	25
Selecting the power level	25
Selecting the run-on time ⁵  ¹⁵	25
Dimming/switching the hob lighting on/off 	25
Power management	26
Safety switch-off	26
Ambient lighting 	26
Energy saving tips	27
Changing settings	28
Altering the operating hours counter for the grease filter(s)	28
Altering or deactivating the charcoal filter operating hours counter	29
Deactivating power management	29

Moisture removal	30
Moisture removal function.....	30
Replacing the dehumidifying filter.....	30
Fragrance	31
Fragrance function.....	31
Removing the fragrance flacon mount	31
Removing the fragrance flacon	31
Storing fragrance flacons when not in use.....	32
Opening the new fragrance flacon	32
Inserting a fragrance flacon.....	32
When to change the fragrance flacon	32
Cleaning and care	33
Housing	33
Operating hours counter  	33
Grease filter(s)	33
Resetting the grease filter operating hours counter	35
Replacing the grease filter.....	35
Charcoal filter	36
Reactivating the charcoal filter	36
Resetting the charcoal filter operating hours counter	37
Service life.....	37
Disposing of charcoal filters	37
Problem solving guide	38
Installation	39
Before installation.....	39
Installation instructions.....	39
Appliance dimensions	40
Installation distance between cooking appliance and cooker hood (S).....	41
Installation recommendations	42
Electrical connection	42
Service	43
Contact in the event of a fault	43
Position of the data plate	43
Warranty	43
Technical data	44
Special accessories for recirculation mode	44
EU Conformity declaration	44
UK Conformity declaration	44

Warning and Safety instructions

This cooker hood complies with all relevant local and national safety requirements. Inappropriate use can, however, lead to personal injury and material damage.

Read the operating and installation instructions carefully before using the cooker hood. They contain important information on its safety, installation, use and maintenance. This prevents both personal injury and damage to the cooker hood.

In accordance with standard IEC 60335-1, Miele expressly and strongly advises that you read and follow the instructions in the chapter on installing the appliance as well as the safety instructions and warnings.

Miele cannot be held liable for injury or damage caused by non-compliance with these instructions.

Keep these instructions in a safe place and pass them on to any future owner.

Correct application

- ▶ This cooker hood is intended for use in domestic households and similar working and residential environments.
- ▶ The cooker hood is not intended for outdoor use.
- ▶ It must only be used as a domestic appliance to extract vapours and remove odours from cooking.
Any other usage is not supported by the manufacturer and could be dangerous.
- ▶ The cooker hood can only be used by people with reduced physical, sensory or mental capabilities, or lack of experience and knowledge, if they are supervised whilst using it, or have been shown how to use it in a safe way and recognise and understand the consequences of incorrect operation.

Safety with children

- ▶ Children under 8 years of age must be kept away from the cooker hood unless they are constantly supervised.
- ▶ Children aged 8 and older may only use the cooker hood without supervision if they have been shown how to use it and are able to do so in a safe manner. Children must be able to understand and recognise the possible dangers caused by incorrect operation.
- ▶ Children must not be allowed to clean or maintain the cooker hood unsupervised.
- ▶ Please supervise children in the vicinity of the cooker hood and do not let them play with it.
- ▶ The hob lighting is very intensive.
Ensure, in particular, that babies/small children do not look at the light.
- ▶ Danger of suffocation! Whilst playing, children may become entangled in packaging material (such as plastic wrapping) or pull it over their head with the risk of suffocation. Keep packaging material away from children.

Warning and Safety instructions

Technical safety

- ▶ Unauthorised installation, maintenance and repairs can cause considerable danger for the user. Installation, maintenance and repairs must only be carried out by a Miele authorised technician.
- ▶ A damaged appliance can be dangerous. Check it for visible signs of damage. Do not use a damaged appliance.
- ▶ The electrical safety of this appliance can only be guaranteed when correctly earthed. It is essential that this standard safety requirement is met. If in any doubt please have the electrical installation tested by a qualified electrician.
- ▶ Temporary or permanent operation on an autonomous power supply system or a power supply system that is not synchronised with the mains power supply (e.g. island networks, back-up systems) is possible. A prerequisite for operation is that the power supply system complies with the specifications of EN 50160 or an equivalent standard.

The function and operation of the protective measures provided in the domestic electrical installation and in this Miele product must also be maintained in isolated operation or in operation that is not synchronised with the mains power supply, or these measures must be replaced by equivalent measures in the installation. As described, for example, in the current version of BS OHSAS 18001–2 ISO 45001.

- ▶ The connection data (voltage and frequency) on the data plate of the cooker hood must match the mains electricity supply in order to avoid the risk of damage to the cooker hood
Compare this before connecting the appliance to the mains. Consult a qualified electrician if in any doubt.
- ▶ Do not connect the appliance to the mains electricity supply by a multi-socket unit or an extension lead. These are a fire hazard and do not guarantee the required safety of the appliance.

Warning and Safety instructions

▶ The support cables also carry the power supply. They must not be kinked or shortened. The support cables must not be used for securing other components such as a shelf.

If a support cable is damaged, the cooker hood must not be operated. The support cables must only be replaced by a Miele authorised service technician to protect the user from danger.

▶ For safety reasons, this appliance may only be used after it has been built in.

▶ The cooker hood must not be used in a non-stationary location (e.g. on a ship).

▶ Touching electrical components and tampering with electrical and mechanical parts is highly dangerous to the user and can cause operational faults.

Only open the housing as described in the instructions given in the installation sheet and in the Cleaning and care section of this booklet. Under no circumstances should any other parts of the housing be opened.

▶ The manufacturer's warranty will be invalidated if the appliance is not repaired by a Miele authorised technician.

▶ The lamps are a built-in component of the lighting. Replacement lamps may only be fitted by a Miele authorised technician or by the Miele Customer Service Department.

▶ During installation, maintenance and repair work, the appliance must be disconnected from the mains electricity supply.

Warning and Safety instructions

Correct use

- ▶ Open flames are a fire hazard.

The use of an open flame under the cooker hood is not permitted. To avoid the danger of fire, do not flambé or grill over an open flame.

When switched on, the cooker hood could draw flames into the filter. Fat deposits could ignite, presenting a fire hazard.

- ▶ Always switch the cooker hood on when a cooking zone is in use, otherwise condensation may collect in the hood, which could cause corrosion.

- ▶ Overheated oil and fat can ignite, causing fire damage to the cooker hood.

When cooking with oil or fat, chip pans and deep fat fryers, etc, do not leave the pans unattended. Similarly, never leave an open grill unattended when grilling.

- ▶ Do not use the cooker hood without the filters in place. This way you will avoid the risk of grease and dirt getting into the appliance and hindering its smooth operation.

- ▶ The cooker hood can get very hot during cooking due to heat rising from the hob.

Do not touch the housing or the grease filters until the cooker hood has cooled down.

- ▶ This cooker hood is not suitable for placing objects on.

- ▶ The support cables could become damaged if the load is too heavy. Do not allow the canopy to swing excessively and do not twist the canopy. Do not pull on the support cables.

Using a fragrance flacon (optional accessory)

- ▶ Only use genuine Miele original fragrance flacons intended for use in the cooker hood .
- ▶ The fragrance flacon must be stored in its packaging so please make sure you retain this.
- ▶ Caution: The fragrance can leak out of the flacon. Make sure that you always keep the fragrance flacon or mount with the flacon inserted in it in an upright position when carrying and do not tip or place it down on any surface.
- ▶ Use an absorbent cloth to wipe up any fragrance which has leaked out of the flacon.
- ▶ If fragrance which has leaked out of a flacon: comes into contact with the **skin** - wash the skin thoroughly with soap and water; comes in contact with the **eyes** - rinse the eyes with clean water for at least 15 minutes; is swallowed - rinse out the **mouth** thoroughly with clean water. Seek medical advice in the case of contact with the eyes or if fragrance has been swallowed.
- ▶ If fragrance which has leaked out of a flacon comes in contact with clothing, change the clothing immediately. Wash the clothing or any cloths used for mopping up fragrance thoroughly with plenty of water and detergent.
- ▶ There is the risk of fire or damage if the following instructions are not observed:
 - Never refill a flacon with fragrance.
 - Never use a faulty fragrance flacon.
- ▶ Dispose of an empty fragrance flacon with the household waste and never use it for any other purpose.
- ▶ Please also observe the information supplied with the fragrance flacon.

Warning and Safety instructions

Proper installation

- ▶ To determine whether a cooker hood may be operated above your cooking appliance, please refer to the information provided by the appliance's manufacturer.
- ▶ Safety regulations prohibit the fitting of a cooker hood over solid fuel stoves.
- ▶ Safety regulations prohibit the fitting of a cooker hood over a gas hob.
- ▶ An insufficient safety distance between the hob and the cooker hood can result in damage to the cooker hood.
The minimum safety distances between the top of the cooker or hob and the bottom of the cooker hood given in the "Installation" section of this booklet must be maintained, unless the hob manufacturer states that a greater safety distance is required.
If more than one cooking appliance is fitted beneath the cooker hood, and they have different minimum safety distances to the cooker hood, select the greater distance.
- ▶ The information provided in "Installation" must be observed when fixing the ventilation hood.
- ▶ The cooker hood is delivered pre-assembled. The support cables must not be dismantled for the purpose of installation.

Cleaning and care

- ▶ There is a risk of fire if the cooker hood is not cleaned as described in these operating instructions.
- ▶ Do not use a steam cleaning appliance to clean this appliance. The steam could reach electrical components and cause a short circuit.

Warning and Safety instructions

- ▶ The charcoal filters must not be cleaned in a dishwasher. High oven temperatures used in subsequent reactivation in an oven can cause detergent residues to self-ignite. Please observe the instructions given in this manual with regards to reactivating the charcoal filters.

Accessories and spare parts

- ▶ Only use genuine original Miele accessories and spare parts with this appliance. Using accessories or spare parts from other manufacturers will invalidate the warranty and Miele cannot accept liability.
- ▶ Miele can only guarantee the safety of the appliance when genuine original Miele replacement parts are used. Faulty components must only be replaced by Miele spare parts.
- ▶ Miele will guarantee to supply functional spare parts for a minimum of 10 years and up to 15 years following the discontinuation of your vapour extraction unit.

Caring for the environment

Disposing of the packaging material

The packaging material is used for handling and protects the appliance from transport damage. The packaging material used is selected from materials which are environmentally friendly for disposal and can generally be recycled.

Recycling the packaging material reduces the use of raw materials. Use material-specific collection points for valuable materials and take advantage of return options. Your Miele dealer will take the packaging material away.

Disposing of your old appliance

Electrical and electronic appliances contain many valuable materials. They also contain certain materials, compounds and components which were essential for their correct functioning and safety. These could be hazardous to human health and to the environment if disposed of with household waste or if handled incorrectly. Please do not, therefore, dispose of your old appliance with household waste.



Instead, please make use of officially designated collection and disposal points to dispose of and recycle electrical and electronic appliances in your local community, with your dealer or with Miele, free of charge. By law, you are solely responsible for deleting any personal data from the old appliance prior to disposal. You are legally obliged to remove any old batteries which are not securely enclosed by the appliance and to remove any lamps without destroying them, where this is possible. These must be taken to a suitable collection point where they can be handed in free of charge. Please ensure that your old appliance poses no risk to children while being stored for disposal.

Recirculation mode

This cooker hood operates solely in recirculation mode.

The air is drawn in and cleaned first by the grease filter and must then go through a dehumidifying filter.

The cleaned air then goes through a charcoal filter before being recirculated back into the kitchen via the top of the cooker hood.

The dehumidifying filter draws in some of the moisture from the vapours produced during cooking. After cooking, the moisture collected by the filter is released back into the ambient air based on information from sensors.

Fragrance

The cooker hood is equipped with a fragrance module with a fragrance flacon. The fragrance module emits a fragrance into the room, regardless of whether the cooker hood is operating. The fragrance feature is controlled exclusively via the Miele@mobile app.

Operating the appliance with the Miele@mobile app

The cooker hood is operated exclusively with the Miele@mobile app or automatically in conjunction with the hob with the Con@ctivity function.

In exceptional cases, the cooker hood can be operated using the control panel on the lower side, e.g. if the WiFi connection has been interrupted.

Guide to the cooker hood

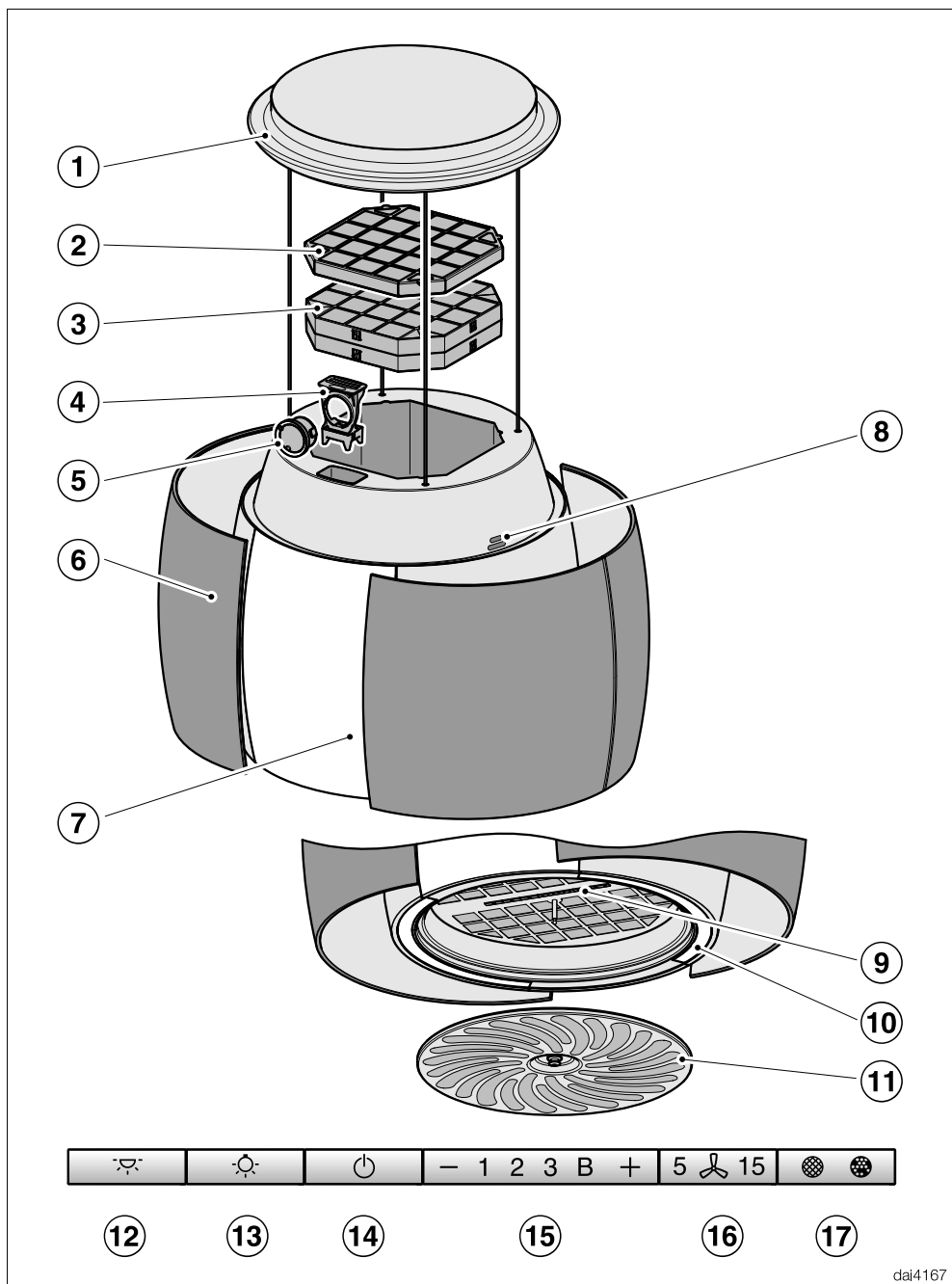

- ① Suspension element
- ② Reactivable charcoal filter
- ③ Dehumidifying filter
- ④ Fragrance flacon mount
- ⑤ Fragrance flacon
- ⑥ Canopy
- ⑦ Ambient lighting
- ⑧ Moisture sensor
- ⑨ Control elements
- ⑩ Hob lighting
- ⑪ Grease filter
- ⑫ Button for switching the ambient lighting on and off
- ⑬ Control for switching the lighting on and off
- ⑭ Control for switching the fan on and off
- ⑮ Controls for setting the fan power level
- ⑯ Control for the run-on function
- ⑰ Control for the operating hours counter

Before using for the first time

The settings described in this chapter are made on the cooker hood control panel. The control panel is located behind the grease filter.

- Remove the grease filter.

Setting up Miele@home

Requirements:

- A WiFi network
- The Miele app
- A Miele user account. The user account can be created via the Miele app.

Your cooker hood is equipped with an integrated WiFi module. Connect the cooker hood to your household WiFi network. You will then be able to operate the cooker hood via the Miele app.

If your Miele hob is connected to a home WiFi network, you can control the cooker hood automatically via the Con@ctivity function.

Before installing the cooker hood in its final location, ensure that the signal of your WiFi network is strong enough.

You can connect to the household WiFi network via the Miele app or via WPS.

Miele@home availability

The ability to use the Miele app depends on the availability of the Miele@home service in your country.

The Miele@home service is not available in every country.

For information about availability, please visit www.miele.com.

Miele App

The Miele App is available to download free of charge from the Apple App Store[®] or from the Google Play Store[™].



Before using for the first time

Connecting via the app

The Miele app can be used to connect to your network.

- Install the Miele app on your mobile device.

For the registration, you will need:

1. Your WiFi network password
2. Your cooker hood password



The password for your cooker hood consists of the last 9 digits of the serial number. This can be found on the appliance's data plate.

The data plate is visible after removing the grease filter(s).



- Start signing the appliance on in the app. Follow the signing-on instructions.

If requested to activate WiFi on the cooker hood, proceed as follows:

- Switch the cooker hood off.



- Press and hold the + control.



- Press the lighting control at the same time.

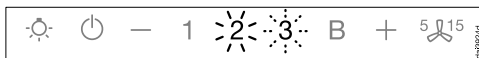

2 will light up constantly, **3** will flash on and off.

The cooker hood will be ready for connection in the next 2 minutes.



- Follow the instructions in the app.

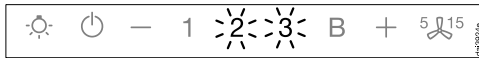

When successfully connected, **2** and **3** will light up constantly.



- Quit connection mode on the cooker hood by pressing the run-on control.

The cooker hood can now be operated via the app.

Before using for the first time

Connecting via WPS

Your WiFi router must support WPS (WiFi Protected Setup).

- Switch the cooker hood off.



- Press and hold the + control.



- Press the lighting control at the same time as the lighting control icon.

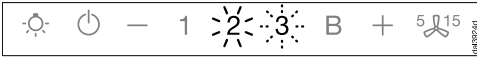

2 will light up constantly, 3 will flash on and off.

The WiFi connection must be started on the cooker hood at the same time as on the WiFi router.

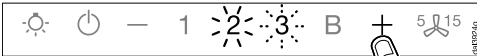

- Press the + control on the cooker hood after a few seconds.

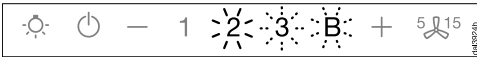

After a short while the 2 will light up constantly, and the 3 and the B will flash on and off.

The cooker hood is ready for connection in the next two minutes.



- Start the WiFi connection on your WiFi router.

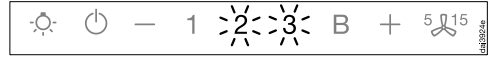

When successfully connected the 2 and 3 will light up constantly.



- Quit connection mode on the cooker hood by pressing the Run-on control 5 15.

The cooker hood can now be operated via the app.

If the connection fails, you have probably not connected WPS on your router quickly enough. Repeat the steps above.

Tip: If your WiFi router does not support WPS, please connect via the Miele app.

Before using for the first time

Sign out of WiFi (reset to factory settings)

To set up a new WiFi connection, the existing WiFi connection must be disconnected.

- Switch the cooker hood off.



- Press and hold the — control.



- Touch the lighting control at the same time ☀.

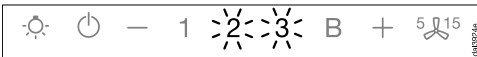

With an existing WiFi connection, **2** and **3** will light up constantly.

The cooker hood will be ready for disconnection in the next 2 minutes.



- Touch the — control.

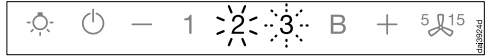

2 will light up constantly, **3** will flash on and off.



After a few seconds, **2** and **3** will flash on and off. The connection has now been disconnected.



- Quit signing-off mode on the cooker hood by pressing the run-on control ⁵15.

The WiFi connection has now been disconnected. A new connection can now be set up.

Before using for the first time

Setting up Con@ctivity

Con@ctivity is the direct communication system between an electric Miele hob and a Miele cooker hood. It enables the cooker hood to operate automatically depending on the operational state of a Miele hob with onset controls.

- When the hob is switched on, the cooker hood lighting comes on automatically and then after a short time the fan also comes on.
- The cooker hood selects the power level automatically during cooking. The power level selected by the cooker hood depends on the number of cooking zones being used and their power levels.
- After switching the hob off the fan and the hob lighting will switch off automatically after a specified period of time.

See “Operation” for detailed information about this function.

Con@ctivity via the home WiFi network (Con@ctivity 3.0)

Prerequisite:

- Home WiFi network
- WiFi-enabled Miele hob

- Connect the cooker hood and hob to your home WiFi network (see “Setting up Miele@home”).

The Con@ctivity function will be activated automatically.

Before using for the first time

Con@ctivity via a direct WiFi connection (Con@ctivity 3.0)

Prerequisite:

- WiFi enabled Miele hob

If you do not have a home network, you can establish a direct connection between the hob and the cooker hood.

- Switch the cooker hood off.



- Press and hold the + control.



- Press the – control at the same time.

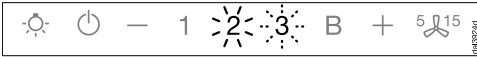

2 will light up constantly, **3** will flash on and off.

The cooker hood will be ready for connection in the next 2 minutes.

- Start WiFi connection on the hob. For further details, see the hob operating instructions.

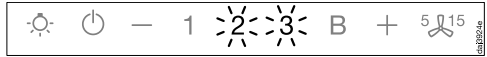

When successfully connected, **2** and **3** will light up constantly.



- Quit connection mode on the cooker hood by pressing the run-on control 5/15.

Con@ctivity has now been activated.

With a direct WiFi connection, it is not possible to connect the hob and the cooker hood to a home network. Should this be required at a later date, the WiFi connection between the hob and the cooker hood must be disconnected (see “Sign out of WiFi”).

Reattempting the connection



If it is not possible to connect, **2** and **3** flash or the cooker hood cancels the process.

- Disconnect the connection to the cooker hood (see “Signing out of WiFi”) and to the hob.
- Attempt to make the connection again.

Operation (Automatic mode)

When Con@ctivity is active, the cooker hood always operates in automatic mode (see “Before using for the first time” – “Setting up Con@ctivity”).

If you wish to manually operate the cooker hood, see “Operation (Manual mode)” – “Cooking without Con@ctivity”.

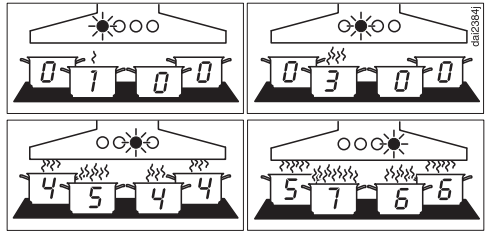

Examples for power levels **1** to **B**

Cooking with Con@ctivity (Automatic mode)

- Switch a cooking zone on at the desired power level.

The hob lighting will come on.

After a few seconds, the fan will come on, first at power level **2**, then it will switch immediately to power level **1**. The deflector plate will open.

The cooker hood selects the fan power level automatically during cooking.

This is determined by the total output of the hob, i.e. the number of cooking zones in operation and the power levels selected.

- If you select a higher power level or are using several cooking zones, the cooker hood will switch to a higher fan power level.
- When you reduce the power level or the number of cooking zones on the hob, the fan power level is also reduced.

Reaction time

The cooker hood reacts with a slight delay because altering the power level on the hob does not immediately result in a reduction or increase in cooking vapours.

Because the hob transmits the information to the cooker hood at intervals, this can also cause delays.

The reaction can vary from a few seconds to a couple of minutes.

Cooking process

- For example, you switch on a cooking zone at the highest power level to heat a pan for frying. You reduce the power level after approx. 10 seconds to 4 minutes (60 seconds to 5 minutes for a HiLight hob).

The cooker hood recognises a cooking process.

The cooker hood switches itself on and when the hob power level has been reduced, the hood switches to fan power level 3 and remains at that level for approx. 5 minutes.

After that, the cooker hood power level is determined automatically by the Con@ctivity function.

You can select another power level manually before then.

Switching off

- Switch off all cooking zones.

The cooker hood fan will reduce its power level in stages over the next few minutes and will then switch itself off.

This helps to neutralise any lingering vapours and odours in the air.

- From the Booster setting, the fan switches immediately to level 3.
- From level 3, it will switch to level 2 after approx. 1 minute.
- From level 2, it will switch to level 1 after 2 minutes.
- After 2 minutes at level 1, the fan switches itself off. The deflector plate closes.
- After another 30 seconds, the lighting switches off.

The cooking process is then finished.

Operation (Automatic mode)

Leaving automatic mode temporarily

To leave automatic mode temporarily during cooking:

- Manually select a different fan power level, or
- Manually switch the cooker hood off, or
- Activate the run-on function  on the cooker hood. The fan will switch itself off after the selected run-on time, and the lighting will remain on.

The cooker hood functions are now operated manually (see “Operation (Manual mode)”).

Returning to automatic mode

The cooker hood will resume automatic mode:

- If the cooker hood has not been used for approx. 5 minutes after selecting a fan power level manually, or
- If the manually selected fan power level corresponds to the automatic one again, or
- The cooker hood fan and the hob have been switched off for at least 30 seconds.
Automatic mode will resume next time the hob is switched on.

You can also operate the cooker hood manually for a complete cooking process.

- Switch the cooker hood fan on **before** the hob.

If the cooker hood fan and the hob have been switched off for at least 30 seconds after cooking, automatic mode will resume next time the hob is switched on.

Cooking without Con@ctivity (Manual mode)

The cooker hood can be operated manually if:

- The Con@ctivity function is not activated.
- You have temporarily deactivated the Con@ctivity function (see “Operation (Manual operation)” – “Leaving automatic mode temporarily”).

You can operate the cooker hood manually via the Miele app exclusively.

You must have Miele@home set up in order to use the Miele app (see “Before using for the first time” – “Setting up Miele@home”).

In exceptional cases, the cooker hood can be operated using the control panel on the lower side, e.g. if the WiFi connection has been interrupted. For this, remove the grease filter.

Switching the fan on and off

Switch the fan on as soon as you start cooking. This is to ensure that vapours are captured right from the start.

The fan will start running at power level **2**. The deflector plate will open.

Selecting the power level

For light to heavy cooking vapours and odours, select from power levels **1** to **3**.

For short periods of cooking food with intensive vapours and a strong aroma, e.g. when searing meat, select Booster setting **B**.

Reducing power down from the Booster setting

If power management is activated (default setting), the fan automatically switches back to level **3** after 5 minutes.

Selecting the run-on time ⁵

It is advisable to run the fan for a few minutes after cooking has finished. This helps to remove any lingering vapours and odours from the air.

It also reduces the risk of residues accumulating in the cooker hood and any resultant odours.

The run-on function enables the fan to continue running for a pre-determined time before switching itself off automatically.

Dimming/switching the hob lighting on/off

The hob lighting can be switched on and off and dimmed independently of the fan.

Operation (Manual mode)



Power management

The cooker hood is fitted with a power management system. Power management helps to save energy. It ensures that the fan power level is reduced automatically and that the lighting is switched off.

- If the Booster setting has been selected, the fan will automatically switch to level 3 after 5 minutes.
- From fan power levels 3, 2 or 1, the power will be reduced by one level after 2 hours and then in 30-minute stages until the fan finally switches off.
- The hob lighting will switch off automatically after 12 hours.

Safety switch-off

If Power management has been deactivated, the cooker hood will switch itself off automatically after 12 hours if it has been left on (fan and hob lighting).

- To switch it on again press the On/Off  control or the lighting control .

Ambient lighting

The ambient lighting is switched on and off at the same time as the fan. However, you can also switch the ambient lighting on and off independently of the fan.

The deflector plate opens and closes when the ambient lighting is switched on and off.

You can change the brightness and light colour using the Miele app.

You can choose different light colours for operation with the fan off and operation with the fan on.

When you switch the appliance on, the lighting will come on at the brightness level and light colour used previously.

This cooker hood operates very efficiently and economically. The following will help you to save even more energy when using it:

- It is important to ensure that the kitchen is well ventilated during operation.
- Always cook with the lowest possible setting. This produces fewer cooking vapours, so you can use a lower cooker hood power level and therefore benefit from reduced energy consumption.
- Clean or change the filters at regular intervals. Heavily soiled filters reduce performance, increase the risk of fire and are unhygienic.
- Use the Con@ctivity function. The cooker hood will switch on and off automatically at the optimum power level for the cooking you are doing, which ensures low energy consumption.
- If you are operating the cooker hood manually, please note the following:
 - Check the power level selected on the cooker hood. A low power level is usually sufficient. Only use the Booster setting when necessary.
 - When a large volume of cooking vapours are being produced, switch to a high power level in good time. This is more efficient than operating the cooker hood for longer to try to capture cooking vapours which have already been distributed throughout the kitchen.
 - Make sure that you switch the cooker hood off after use. If cooking vapours and odours still need to be removed from the kitchen air after cooking, use the run-on function. The fan will switch off automatically after the selected run-on time.

Changing settings

You can adjust the cooker hood settings using the buttons on the cooker hood.

The settings described in this chapter cannot be adjusted via the Miele app.



- Remove the grease filter.

Altering the operating hours counter for the grease filter(s)

You can set the operating hours counter to suit the type of cooking you do.

The factory default setting is a cleaning interval of 30 hours.



- Select a shorter time of 20 hours if you fry a lot.
- If you only cook occasionally, we recommend that you still select a short time. This is to prevent grease hardening on the filter(s) and making cleaning more difficult.
- Select a longer time of 40 or 50 hours if you use very little fat for cooking.

- Switch off the fan and the lighting.
- Press the run-on ⁵⏸¹⁵ control and the operating hours control   at the same time.

The Grease filter symbol  and one of the fan power level indicators will flash.

Fan power level indicators **1** to **B** show the time set:

1	20 hours
2	30 hours
3	40 hours
B	50 hours

- Press the **—** control for a shorter duration, or **+** for a longer duration.
- Confirm your choice with the operating hours control  .



All the indicator lights will go out.

If you don't confirm your selection within 4 minutes, the cooker hood will automatically revert to the original setting.

Altering or deactivating the charcoal filter operating hours counter

You can set the operating hours counter to suit the type of cooking you do.



The factory default setting is a reactivation interval of 180 hours.

- Switch off the fan and the lighting.
- Press the + control and the operating hours control   at the same time.

The charcoal filter symbol  and one of the fan power levels will flash.

Fan power level indicators **1** to **B** show the time set:

Indicator 1	120 hours
Indicator 2	180 hours
Indicator 3	240 hours
Indicator B	deactivated

- Select the duration you want with the + or – control.
- Confirm your choice with the operating hours control  .



All the indicator lights will go out.

If you do not confirm your selection within 4 minutes, the cooker hood will automatically revert to the original setting.

Deactivating power management

Keep in mind that deactivating this function may increase energy consumption.

Activating/deactivating Power Management

- Switch off the fan and the lighting.
- Press the fan run-on control  for approx. 10 seconds until the indicator for fan power level **1** lights up.
- Then press in turn:
 - the lighting control ,
 - the – control, and then
 - the lighting control .

If Power Management is activated, the **1** and **B** indicators light up constantly. When it is deactivated, the **1** and **B** indicators flash.

- Press the – control to deactivate Power Management.

The **1** and **B** indicators will flash.

- Press the + control to activate Power Management.

The **1** and **B** indicators will light up constantly.

- Confirm the setting with the run-on option control .

All the indicator lights will go out.

If you do not confirm your choice of setting within 4 minutes, the cooker hood will revert to the old setting.

Moisture removal

Moisture removal function

The dehumidifying filter draws in some of the moisture from the vapours produced during cooking. After cooking, the dehumidifying filter is dried in a controlled manner using sensors. The moisture collected by the filter is released back into the ambient air. The cooker hood fan will come on for this at a low speed.

When the dehumidifying filter is inserted, activate the moisture removal function via the Miele@mobile app.

Drying is activated between 8:00 a.m. and 10:00 p.m. Over this period, a sensor records the indoor climate and switches the drying function on at a suitable time.

You can change the following settings using the Miele@mobile app:

- You can change the possible time-frame for drying.

Replacing the dehumidifying filter

 Damage due to incorrect cleaning

The dehumidifying filter cannot be cleaned or reactivated. This can cause damage to the dehumidifying filter.

Replace the dehumidifying filter for a new one once it has reached the end of its life.

The dehumidifying filter must be replaced after 3 years.

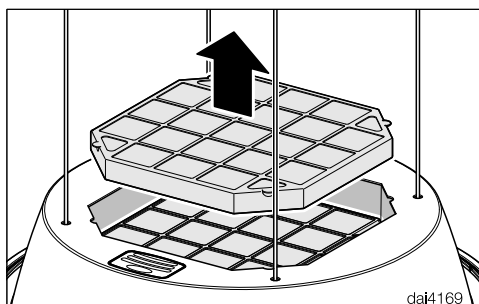

- Remove the charcoal filter from the cooker hood.

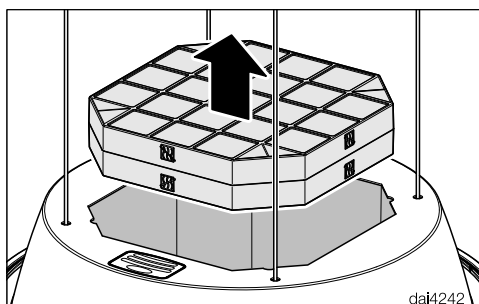

- Remove the dehumidifying filter from the cooker hood and insert a new one.
- Refit the charcoal filter.

Dehumidifying filters are available to order via the Miele online shop, the Miele Customer Service Department (see end of these operating instructions for contact details) or from your Miele dealer.

The model designation required is listed under "Technical data".

Disposing of the dehumidifying filter

- Used dehumidifying filters can be disposed of with normal household waste.

Fragrance function

The fragrance flacon emits a fragrance burst into the room, regardless of whether the cooker hood is operating.

You can control the function with the Miele@mobile app.

You can trigger a one-off fragrance burst or specify times at which fragrance bursts are to be emitted regularly.

⚠ Risk of fire and damage to the health if fragrance flacons are used incorrectly.

The leaked fragrance can damage your health if it comes into contact with your body. Leaked fragrance can cause fire.

Before using a fragrance flacon, please read “Warning and safety instructions”, “Using the fragrance flacon (optional accessory)”.

Removing the fragrance flacon mount

The holder for the fragrance flacon mount is located on the top of the cooker hood.

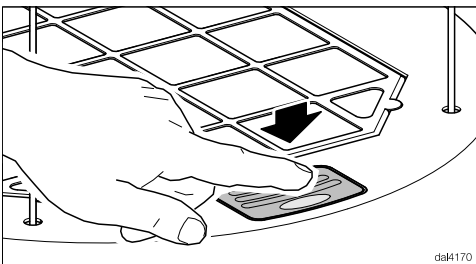

- Press on the fragrance flacon mount.

The fragrance flacon mount will move out of the casing a little.

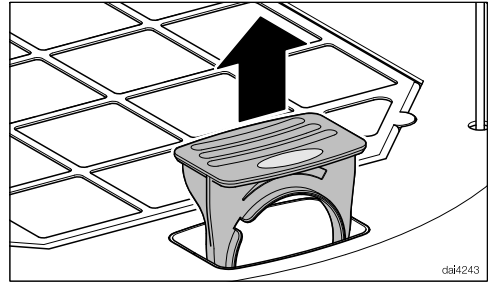

- Pull out the fragrance flacon mount.

Removing the fragrance flacon

If you wish to replace the fragrance flacon, first remove the used fragrance flacon.

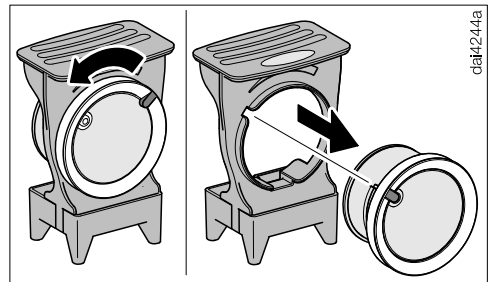

- Turn the outer ring to the left as far as it will go and pull out the fragrance flacon.

Fragrance

Storing fragrance flacons when not in use

If you wish to temporarily store unused fragrance flacons while they are not in use, use the original packaging.

The fragrance can leak out of the flacon.

Do not hold opened fragrance flacons at an angle, tilt them or place them on their back.

If you are keeping the fragrance flacon in its original packaging, do not store the packaging upright on its edge or upside down.

- Put the fragrance flacon in its original packaging and store it in a cool, dry place away from direct sunlight.

Opening the new fragrance flacon

The fragrance can leak out of the flacon.

Only hold the fragrance flacon as illustrated. Do not hold opened fragrance flacons at an angle, tilt them or place them on their back.

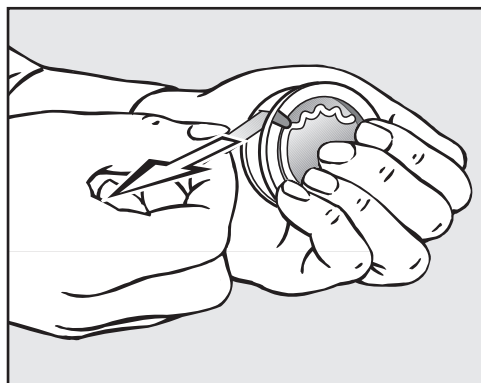

- Grip the fragrance flacon firmly.
- Pull off the protective seal.

Inserting a fragrance flacon

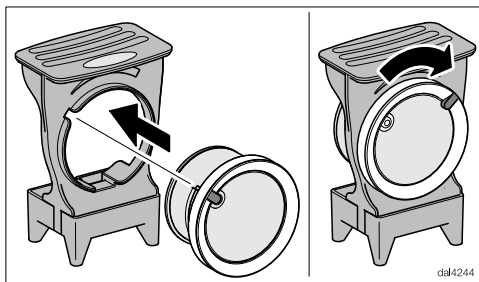

- Insert the fragrance flacon into the opening of the mount as far as it will go.
- Turn the outer ring to the right as far as it will go.

The fragrance flacon is now ready to use.

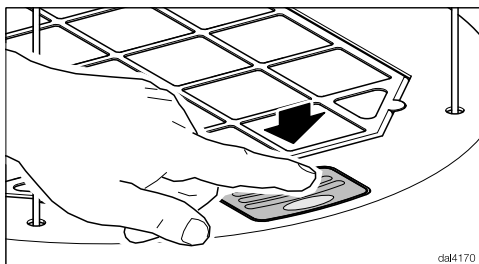

- Insert the fragrance flacon mount in the cooker hood and push it in as far as it will go.

When to change the fragrance flacon

Replace the fragrance flacon when a message appears in the Miele@mobile app or when the intensity of the fragrance is no longer sufficient.

Reset the message after replacing the flacon.

 Before proceeding with any maintenance or cleaning task, the cooker hood must be disconnected from the power supply (see “Warning and Safety instructions”).

Housing

General information

Unsuitable cleaning agents can damage the surfaces and control elements.

Do not use any cleaning agents containing soda, acid, chloride or solvent.

Do not use any abrasive cleaning agents, e.g. powder cleaners or cream cleaners and abrasive sponges, as well as pot scourers or sponges which have been used previously with abrasive cleaning agents.

 Moisture in the cooker hood can cause damage.



Make sure that water does not get into the cooker hood.

- All external surfaces and control elements can be cleaned using hot water with a small amount of washing-up liquid applied with a well wrung-out soft sponge or cloth.
- After cleaning, wipe the surfaces dry using a soft cloth.

Operating hours counter

The cooker hood registers the length of time for which it has been operated.

The Miele app communicates the number of elapsed operating hours and informs you when the grease filter needs to be cleaned or the charcoal filter needs to be reactivated.

At the same time, the grease filter  or charcoal filter  symbol lights up on the cooker hood control elements.

You can set the interval on the operating hours counters to suit the type of cooking you do (see “Changing settings”).

Grease filter(s)

 Fire hazard

An oversaturated grease filter is a fire hazard.

Clean the grease filter at regular intervals.

The re-usable metal grease filter in the appliance remove solid particles from the kitchen vapours (grease, dust, etc.), preventing soiling of the cooker hood.

The grease filter must be cleaned at regular intervals.

A heavily soiled grease filter hinders air extraction and will lead to increased levels of soiling in the cooker hood and in the kitchen.

Cleaning and care

Cleaning interval

Accumulated grease solidifies over a longer period of time and makes cleaning more difficult. The grease filter(s) should therefore be cleaned at least every 3 to 4 weeks.

The operating hours counter reminds you to clean the grease filter regularly (see “Cleaning and care” – “Operating hours counter”).

Removing a grease filter

 When handling a grease filter, be careful not to drop it.

This can result in damage to the filter and the hob below.

Make sure you hold the filter securely at all times when handling it.

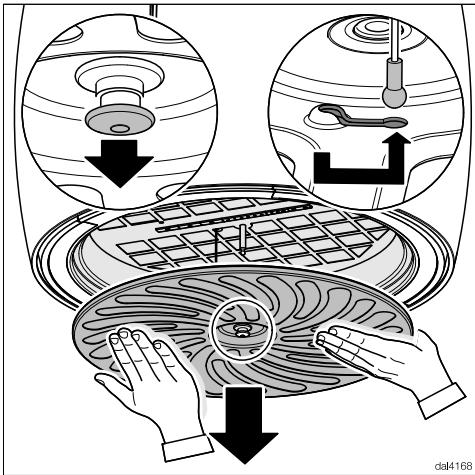

- Pull the grease filter lock downwards.

This will release the grease filter. It is held in position by a safety cord.

- Release the safety cord and remove the grease filter downwards.

Cleaning the grease filter by hand

- Clean the filter with a soft nylon brush in a mild solution of hot water and a small amount of washing-up liquid. Do not use “neat” washing up liquid.

Unsuitable cleaning agents

Unsuitable cleaning agents can cause damage to the surface of the filters if used regularly.

Do not use:

- cleaning agents containing descaling agents
- powder cleaners, cream cleaners
- aggressive multi-purpose cleaning agents or spray cleaners for grease
- oven sprays

Cleaning the grease filter in a dishwasher

- Place the grease filter flat or slightly inclined in the upper or lower basket. Ensure the spray arm is not obstructed.
- Use a standard household dishwasher detergent.
- Select a dishwasher programme with a wash temperature between 50 °C and 65 °C.



Depending on the detergent used, cleaning the grease filter in a dishwasher can cause permanent discoloration to the internal surfaces of the filter. However, this will not affect the functioning of the grease filter in any way.

After cleaning

- After cleaning, leave the filter to dry on an absorbent surface before replacing it.
- When removing the filter for cleaning, also clean off any residues of oil or fat from the now accessible casing to prevent the risk of these catching fire.
- When you reinsert the grease filter, hook the safety cord into the grease filter.
- Insert the grease filter and push it upwards in the middle until it locks into place.



Resetting the grease filter operating hours counter

After cleaning, the operating hours counter needs to be reset via the buttons on the cooker hood.

- With the fan switched on, press the operating hours button   for approximately 3 seconds until only **1** is flashing.

The grease filter symbol  goes out.

If you want to clean the grease filter before the operating hours counter has reached its maximum:

- Press the operating hours button   for approximately 6 seconds until only **1** is flashing.

Replacing the grease filter

Regular usage and cleaning can cause the filter surfaces to become worn.

If you identify any damage, replace the grease filter.

Grease filters are available to order via the Miele Customer Service Department (see end of these operating instructions for contact details) or from your Miele dealer.

Cleaning and care

Charcoal filter

A charcoal filter is designed to absorb cooking odours. It is used in addition to a grease filter.

The charcoal filter is fitted in the top of the cooker hood.

This charcoal filter can be reused several times by reactivating it in an oven or in a combination steam oven.

Reactivation interval

Reactivate the charcoal filter when it no longer absorbs kitchen odours effectively, and at least every 6 months.

The operating hours counter reminds you to reactivate the charcoal filter regularly (see “Cleaning and care” – “Operating hours counter”).

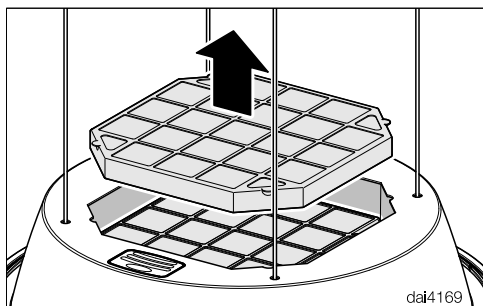

- Remove the charcoal filter from the cooker hood.

Reactivating the charcoal filter

The charcoal filter can be reactivated to restore its functionality. It must be reactivated in an oven or in a combination steam oven using the oven function only.

⚠ Fire hazard

If the charcoal filter is cleaned in a dishwasher, detergent residues may self-ignite during subsequent reactivation in an oven.

Do not clean the charcoal filter in a dishwasher.

Cleaning the charcoal filter by hand may cause it to become damaged.

Do not wash the charcoal filter by hand.

The charcoal filter is breakable.

When handling it, be careful not to drop it. Do not press against the webbing either.

- If there is a removable grease filter in the back of the oven compartment, please remove it. Further information is provided in the relevant operating instructions.
- Do not pre-heat the oven. Place the charcoal filter on the rack in the centre of the oven.
- Switch the oven or the oven function of your combination steam oven on and select: Fan plus  (recirculation) 200 °C.

Odours may arise during reactivation.

Reactivation should be carried out in a well-ventilated room. Open a window if necessary.

- Reactivation takes 60 minutes. Switch the oven or the oven function on your combination steam oven off once this process has finished.



Danger of burning

You could burn yourself on the hot charcoal filter.



Do not take the charcoal filter out of the oven while it is still hot and do not place it on heat-sensitive surfaces while it is hot.

Do not refit the charcoal filter in your cooker hood whilst still hot.

- Leave it in the oven compartment until it has cooled down.
- Refit the charcoal filter once it has cooled.



Resetting the charcoal filter operating hours counter

After the charcoal filter has been reactivated, the operating hours counter needs to be reset on the cooker hood control panel.

- Remove the grease filter.
- With the fan switched on, press the operating hours button   twice, then hold it for approximately 3 seconds until only **1** is flashing.

The charcoal filter symbol  will go out.

If you want to reactivate the charcoal filters **before** the operating hours counter has reached its maximum:

- Press the operating hours button   twice and hold it for approximately 6 seconds until only **1** is flashing.
- Replace the grease filter.

Service life

The charcoal filter should be replaced every 3 years.

Charcoal filters are available to order via the Miele online shop, the Miele Customer Service Department (see end of these operating instructions for contact details) or from your Miele dealer.

The model designation required is listed under "Technical data".

Disposing of charcoal filters

- Used charcoal filters can be disposed of with normal household waste.

Problem solving guide

Many malfunctions and faults that can occur in daily operation can be easily remedied. Time and money will be saved because a service call will not be needed.

The following guide may help you to find the reason for a malfunction or a fault, and to correct it.

Problem	Cause and remedy
The deflector plate is not opening or closing correctly, e.g. after a power failure.	There is a fault with the controls. <ul style="list-style-type: none">■ Remove the grease filter.■ Press “-”, “+”, “+” and “-” in succession on the control panel. The deflector plate will open and close once or several times.

Before installation

 Before installation, it is important to read the information given on the following pages as well as the “Warning and Safety instructions” at the beginning of this booklet.

Installation instructions

See enclosed Installation sheet for instructions on how to install this appliance.

Installation

Appliance dimensions

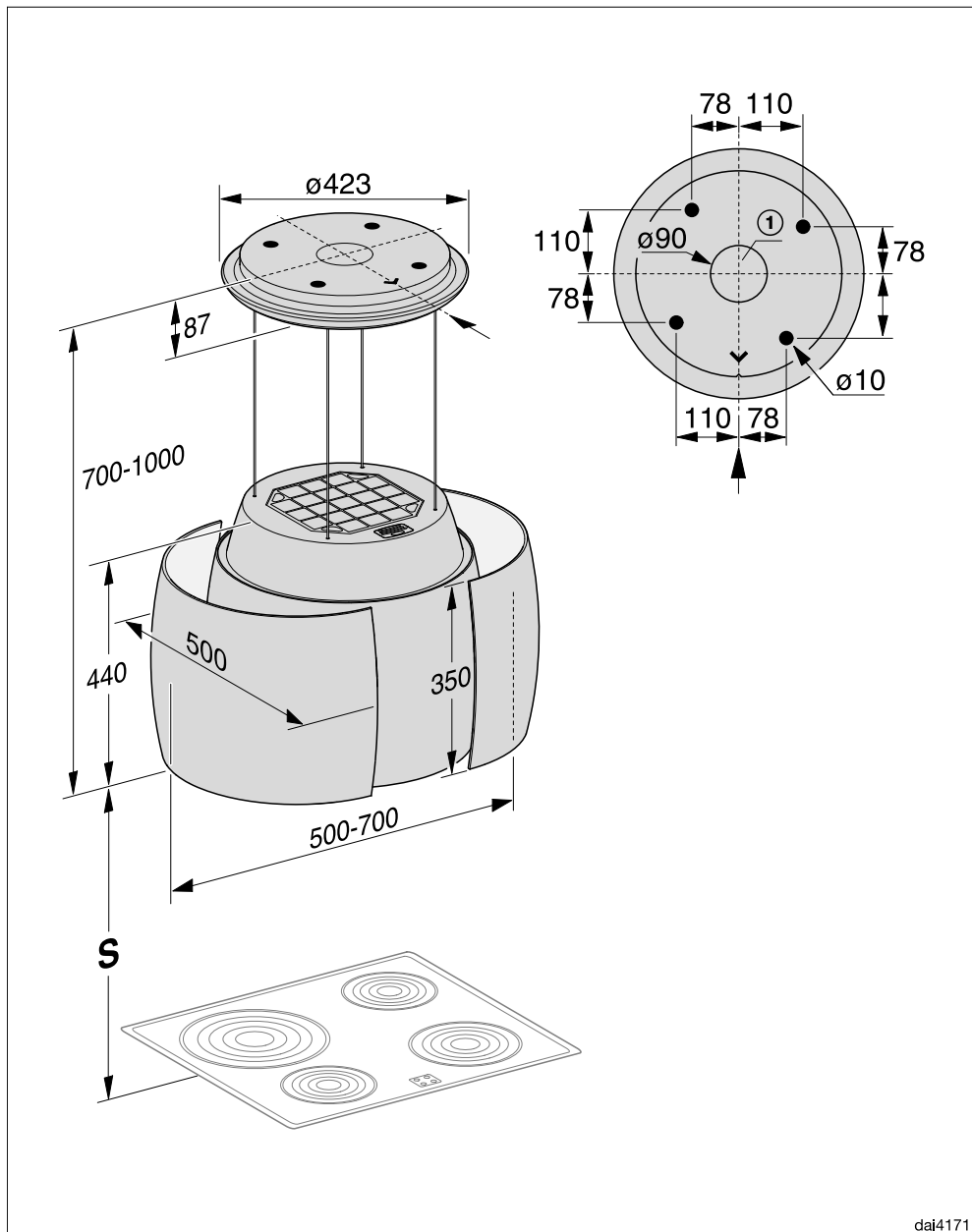

dai4171

- ① Cut-out for mains cable

Installation distance between cooking appliance and cooker hood (S)



Risk of heat damage.

The rising heat generated by a gas hob may damage the cooker hood. Fitting this cooker hood over a gas hob is not permitted.

When planning the installation distance between the cooking appliance and the bottom of the cooker hood, the information provided by the cooking appliance manufacturer must be taken into account.

Unless a greater distance is specified by the cooking appliance manufacturer, the minimum safety distances indicated below must be ensured.

Please also observe the information given under “Warning and safety instructions”.

Cooking appliance	Minimum distance S
Electric hob	450 mm
Electric grill, electric fryer	650 mm

Installation

Installation recommendations

- When deciding on the safety distance between the hob and cooker hood, please note that a distance of 650 mm above electric cookers/hobs may be preferable to give more working space under the hood.
- Account should also be taken of the height of the person who will be using the hood most often. They should have sufficient space to work comfortably at the hob, and be able to reach the cooker hood controls with ease.
- Please be aware that if positioned too high, extraction will be inefficient.
- To achieve optimum vapour extraction, the cooker hood must be centred over the hob, not to the side or behind it.
- The hob should be no wider than the cooker hood, and if possible, it should be narrower.
- The installation area must be easily accessible. The cooker hood should be easily accessible and easy to dismantle in the event that service is required. This should be taken into consideration when planning the position of cupboards, shelves, ceilings or features in the vicinity of the cooker hood.

Electrical connection

 Installation, maintenance or repair work by unqualified persons could be extremely dangerous. The manufacturer cannot be held liable for unauthorised work.

All electrical work should only be undertaken by a suitably qualified and competent electrician in strict accordance with current national and local safety and building code regulations.

This cooker hood must only be connected to a properly installed power supply. The electrical installation must be in compliance with current local and national safety regulations, (e.g. VDE 0100 in Germany/BS 7671 in the UK).

For increased safety we recommend the use of a residual current device with a trip current of 30 mA (DIN VDE 0664).

A suitable means of disconnection must be provided on site for each pole. Suitable means of disconnection include switches with an all-pole contact gap of at least 3 mm. These include circuit breakers, fuses and contactors (EN 60335).

The relevant connection data can be found on the data plate (see “After Sales/Warranty”). Ensure that this data matches the voltage and frequency of your household power supply.

Contact in the event of a fault

In the event of any faults which you cannot remedy yourself, please contact your Miele dealer or the Miele Customer Service Department.

You can book a Miele Customer Service Department call-out online at www.miele.com/service.

Contact information for the Miele Customer Service Department can be found at the end of this document.

Please quote the model identifier and serial number of your appliance (Fabr./SN/Nr.) when contacting the Miele Customer Service Department. This information can be found on the data plate.

Please note that telephone calls may be monitored and recorded for training purposes and that a call-out charge will be applied to service visits where the problem could have been resolved as described in this booklet.

Position of the data plate

The data plate is visible after removing the grease filter.

Warranty

For information on the appliance warranty specific to your country please contact Miele. See back cover for address.

In the UK, your appliance warranty is valid for 2 years from the date of purchase. However, you must activate your cover by calling 0330 160 6640 or registering online at www.miele.co.uk.

Technical data

Fan motor	105 W
Hob lighting	10 W
Ambient lighting	15.4 W
Total rated load	130.4 W
Mains voltage, frequency	AC 230 V, 50 Hz
Fuse rating	10 A
Weight	24.6 kg

WiFi module

Frequency band	2.400–2.4835 GHz
Maximum transmission power	< 100 mW

Special accessories for recirculation mode

Charcoal filter DKF 28-R (reactivatable)

Dehumidifying filter DAEF 28

EU Conformity declaration

Miele hereby declares that this cooker hood complies with Directive 2014/53/EU.

The complete text of the EU declaration of conformity is available from one of the following internet addresses:

- Products, Download from www.miele.ie
- For service, information, operating instructions etc: go to www.miele.ie/domestic/customer-information-385.htm and enter the name of the product or the serial number

UK Conformity declaration

Miele hereby declares that this cooker hood complies with UK Radio Equipment Regulations 2017, as amended.

The complete text of the UK declaration of conformity is available from one of the following internet addresses:

- Products, Download from www.miele.co.uk
- For service, information, operating instructions etc: go to www.miele.co.uk and enter the name of the product or the serial number

Data sheet for household cooker hoods

In acc. with delegated regulation (EU) No. 65/2014 and regulation (EU) No. 66/2014

MIELE	
Model name/identifier	DA 7378 D Aura4.0 Ambient
Annual Energy Consumption (AEC _{hood})	31,6 kWh/year
Energy efficiency class	A+
Energy efficiency index (EEI _{hood})	44,8
Fluid Dynamic Efficiency (FDE _{hood})	35,1
Fluid Dynamic Efficiency class	
A (most efficient) to G (least efficient)	A
Lighting Efficiency (LE _{hood})	35,0 lx/W
Lighting Efficiency class	
A (most efficient) to G (least efficient)	A
Grease Filtering Efficiency	95,1 %
Grease Filtering Efficiency class	
A (most efficient) to G (least efficient)	A
Airflow at best efficiency point	328,7 m ³ /h
Air flow (min. speed)	240 m ³ /h
Air flow (max. speed)	440 m ³ /h
Air flow (intensive or boost setting)	600 m ³ /h
Max. air flow (Q _{max})	600 m ³ /h
Air pressure at best efficiency point	348 Pa
Airborne acoustical A-weighted sound power emissions (min. speed)	53 dB
Airborne acoustical A-weighted sound power emissions (max. speed)	66 dB
Airborne acoustical A-weighted sound power emissions (intensive or boost setting)	73 dB
Electrical power input at best efficiency point	90,3 W
Power consumption in off mode (P _o)	W
Power consumption in standby mode (P _s)	0,35 W
Nominal power of lighting system	10,0 W
Average illumination of the lighting system on the cooking surface	350 lx
Time increase factor	0,7

United Kingdom

Miele Co. Ltd., Fairacres, Marcham Road, Abingdon, Oxon, OX14 1TW

Tel: 0330 160 6600, Internet: www.miele.co.uk/service, E-mail: info@miele.co.uk

Australia

Miele Australia Pty. Ltd.

ACN 005 635 398

ABN 96 005 635 398

Level 4, 141 Camberwell Road

Hawthorn East, VIC 3123

Tel: 1300 464 353

Internet: www.miele.com.au

China Mainland

Miele Electrical Appliances Co., Ltd.

1-3 Floor, No. 82 Shi Men Yi Road
Jing' an District

200040 Shanghai, PRC

Tel: +86 21 6157 3500

Fax: +86 21 6157 3511

E-mail: info@miele.cn,

Internet: www.miele.cn

Hong Kong, China

Miele (Hong Kong) Ltd.

41/F - 4101, Manhattan Place

23 Wang Tai Road

Kowloon Bay, Hong Kong

Tel: (852) 2610 1025

Fax: (852) 3579 1404

Email:

customerservices@miele.com.hk

Website: www.miele.hk

India

Miele India Pvt. Ltd.

1st Floor, Copia Corporate Suites,
Commercial Plot 9,

Mathura Road, Jasola,

New Delhi - 110025

E-mail: customercare@miele.in

Website: www.miele.in

Ireland

Miele Ireland Ltd.

2024 Bianconi Avenue

Citywest Business Campus

Dublin 24

Tel: (01) 461 07 10

Fax: (01) 461 07 97

E-Mail: info@miele.ie

Internet: www.miele.ie

Malaysia

Miele Sdn Bhd

Suite 12-2, Level 12

Menara Sapura Kencana

Petroleum

Solaris Dutamas No. 1

Jalan Dutamas 1

50480 Kuala Lumpur, Malaysia

Phone: +603-6209-0288

Fax: +603-6205-3768

New Zealand

Miele New Zealand Limited

IRD 98 463 631

8 College Hill

Freemans Bay, Auckland 1011

New Zealand

Tel: 0800 464 353

Internet: www.miele.co.nz

Singapore

Miele Pte. Ltd.

29 Media Circle

#11-04 ALICE@Mediapolis

Singapore 138565

sTel: +65 6735 1191

Fax: +65 6735 1161

E-Mail: info@miele.com.sg

Internet: www.miele.sg

South Africa

Miele (Pty) Ltd.

63 Peter Place

Bryanston 2194

P.O. Box 69434

Bryanston 2021

Tel: (011) 875 9000

Fax: (011) 875 9035

E-mail: info@miele.co.za

Internet: www.miele.co.za

Thailand

Miele Appliances Ltd.

BHIRAJ TOWER at EmQuartier

43rd Floor Unit 4301-4303

689 Sukhumvit Road

North Klongton Sub-District

Vadhana District

Bangkok 10110, Thailand

United Arab Emirates

Miele Appliances Ltd.

Showroom 1

Eiffel 1 Building

Sheikh Zayed Road, Umm Al Sheif

P.O. Box 114782 - Dubai

Tel. +971 4 3044 999

Fax. +971 4 3418 852

800-MIELE (64353)

E-Mail: info@miele.ae

Website: www.miele.ae

Manufacturer: Miele & Cie. KG, Carl-Miele-Straße 29, 33332 Gütersloh, Germany

DA 7378 D

en-GB

M.-Nr. 12 103 140 / 00